

proofed and located out of doors. In addition, the deaerating heater, evaporator, and miscellaneous tanks are mounted out of doors. The steam-generating units in late designs have been of the pressurized type in the South, using only pressure blowers to supply combustion air and remove the furnace gases.

Table 7 indicates the details in connection with each of these stations. We believe that the outdoor boiler is firmly established. We do believe, however, that there is an open question as to whether the outdoor type of turbine saves any appreciable investment. We also feel that for the outdoor boiler and turbine plants, an enclosed central control room with adequate glazing will give the operators needed weather protection, will improve their vision of operating conditions, and will reduce operating manpower.

It is also necessary with outdoor design to weatherproof certain pipe lines, which cannot be drained or wherein water may freeze. We have applied antifreeze protection to our more recent outdoor plants. This has been done with electric strip heaters, either with or without monitoring indicators. Protection also can be done by steam tracing various pipe lines. Costs can be reduced by grouping various lines around a central source of heat.

In all, our firm has under design, or has completed, some 25 station units for outdoor service. We believe that the outdoor plant has its place particularly in the type of climate where the plant is not subject to extremes of weather.

General Discussion

W. L. CHADWICK.⁹ The advantages of outdoor stations and the opportunities for economies in construction and operation which they present have long been recognized in Southern California. The feasibility of operating outdoor stations in this area has been demonstrated by the petroleum industry with many years of successful operation of outdoor refineries including complex high-temperature and high-pressure equipment.

In 1947 the design features of the semienclosed Redondo No. 1 Plant of the Southern California Edison Company were reported. At the 1952 Spring Meeting of the Society a report¹⁰ was presented on the design features of Etiwanda Steam Station, the first all-outdoor plant of the Southern California Edison Company, which was then under construction. The decision to use an outdoor design here was based on numerous reports from and observations of outdoor plants which had given satisfactory service elsewhere, on the favorable experiences with outdoor oil refineries, and on the reliable operation of many outdoor synchronous condensers on the Edison system going back to 1930.

In that report several advantages of outdoor design were mentioned.

- 1 The elimination of the usual boiler and turbine buildings with an attendant saving of between \$5 and \$8 per kilowatt in first cost.

- 2 Simplifications of design and construction with further savings in first cost and improvement in reliability.

- 3 Elimination of most of the ventilation problems, thereby saving not less than \$75,000 in the first cost of fans as well as saving the continued cost of power and maintenance for such equipment.

- 4 Increased ease of cleaning and the attendant saving by permitting the washing down of open areas rather than sweeping or vacuum cleaning.

- 5 Finally, the outdoor station is safer in case of fire. The exposures to heat, smoke, and water are less and the accessibility for

fire suppression is much improved. This is an advantage which is often overlooked. Several central-station fires have been reported recently in which the heat and smoke from a relatively small fire, concentrated in an enclosed area, made it impossible for the operating force to get close enough either to fight the fire properly or to shut down equipment. Major damage resulted.

To date our experience has been that we have not only realized all of the advantages, but have obtained other incidental benefits. The improved accessibility of the outdoor station has been an important aid during construction. It has been possible to use motorized moving and lifting equipment to better advantage. The elimination of walls extended the reach range of derricks. Construction supervision has been noticeably more effective in the open station, and there has been less interference between structural workers and equipment erectors.

There has been distinctly better operator morale at the outdoor station. Operators prefer the outside duties, often resisting transfers to assignment on which they will be required to work in enclosed areas.

One objection frequently raised to outdoor stations is the exposure during overhaul and repair. Our experience has been that some form of temporary portable housing is essential but quite satisfactory. During initial alignment of the units such housing is necessary to prevent uneven expansion from uneven solar heating. After erection, the shelter can be set aside, but yet used to enable any necessary maintenance work to be continued during unfavorable weather. We do not believe that any walk-in enclosure is desirable because it would provide no protection which cannot be obtained in a weatherproofed unit, yet it presents the same problems in ventilation and much the same exposure to hazard from fire and accidents as in fully enclosed stations.

We believe that the outdoor station design is a natural step in the development of the central station. The first electrical apparatus was all housed, but as designers and manufacturers improved equipment, advantage has been taken of the economy, reliability, and safety which may be gained by moving the generating, transforming, and distributing stations outdoors.

We concede that at some station sites, the problems of noise control may be serious enough to practically eliminate the possibility of outdoor stations. In other areas where low temperatures are encountered the outdoor station may seem unsuitable, but it is often possible to use outdoor boilers and turbine-generators and yet enclose the area beneath the turbine deck at comparatively small cost, thereby providing a protective enclosure for most of the auxiliary equipment.

Our experience with the outdoor station has been so successful that we are incorporating it to the limits of feasibility in two new stations now under construction.

C. C. WHELCHER.¹¹ The Pittsburgh Steam Plant, consisting initially of four units, is scheduled to go into operation during the spring and summer of 1954. It will be a so-called full-outdoor plant. The estimated gross normal operating station capability will be 600,000 kw, making Pittsburgh the largest steam-electric generating station in the west. The estimated cost of the plant, excluding the high-voltage switchyard, is about \$120 per kw of plant.

The weather at this site is mild, with dry summers, and a rainy season averaging about 20 in. per year extending from about November through April. The major problem is expected to come from wind and dust, but the dust will be minimized by planting and yard paving.

⁹ Vice-President, Southern California Edison Company, Los Angeles, Calif. Mem. ASME.

¹⁰ *Mechanical Engineering*, vol. 74, 1952, pp. 543-550.

¹¹ Chief, Steam Engineering Division, Pacific Gas & Electric Company, San Francisco, Calif. Mem. ASME.

This very brief discussion will be limited to the general arrangement and the outdoor features.

The turbine-generators, except for the head end, are out in the open. The boilers are protected only by an umbrella-type roof extending some 9 ft below drum center line. The principal enclosure contains the control room and firing aisle. The protected areas under the boilers and the turbine pedestals also provide economical space for enclosed location of some equipment.

The four turbine-generators are set in parallel with axes normal to the boiler drums, resulting in a minimum piping distance from boiler to turbine. The turbines project from a combination auxiliary equipment bay and firing aisle, with the governor ends of the turbines thus being located inside the auxiliary bay-firing aisle area and accessible to the operators. This feature eliminates the need for the typical walk-in weatherproof enclosure on the governor end of the turbine but a walk-in enclosure is installed over each exciter.

The central control room for the four units is located between units Nos. 2 and 3 in the enclosed combination firing aisle and turbine operating area just discussed.

The turbine-generators are serviced by a 60-ton semigantry crane, having access also to the high-pressure feedwater heaters, to the spur track, and to an open lay-down area at grade adjacent to the machine shop. During construction and when required for maintenance on a turbine-generator, a mobile canvas shelter on an aluminum tubular frame is provided.

Fans are located outdoors on the ground behind the boilers, with two forced and two induced-draft units per boiler.

While the Pittsburgh Steam Plant would be designated as a full-outdoor plant, the over-all design has attained a considerable degree of enclosure for operators and certain equipment by taking full advantage of numerous structural situations where low-cost enclosure could be made at desirable points.

The arrangement of the Pittsburgh plant is the end result of a continuous effort by PG&E to build stations that are economical from the standpoint of investment, and operating and maintenance costs. At this plant the largest item of saving came from the decision to make this a completely outdoor plant—the first such plant on our system—although we have a number of other outdoor boilers. Along with this the decision to rearrange our turbine-generator layout from the in-line or common-axis arrangement greatly reduced piping and electrical costs. The total savings for the outdoor over a masonry-enclosed arrangement plus the improved turbine-generator arrangement was estimated at between \$1,000,000 and \$1,500,000.

We cannot as yet fully evaluate the effect of the outdoor turbine arrangement on possible operating and maintenance problems and costs, but we anticipate that the plant will be a practical and simple one to operate and maintain, and that over-all operating costs will not be increased by the outdoor features.

J. W. KECK.¹² We have eight major plants with a total of 21 units installed. Of these units, ten are conventional indoor plants, three semioutdoor plants, i.e., outdoor boiler, two are something between semi and full-outdoor, having a low steel enclosure over the entire turbogenerator, and five are full-outdoor plants. With one exception, the indoor plants were built prior to 1940, the semioutdoor plants were built in the period 1942-1946, and since 1948 eight units have been built in progressive degrees of full-outdoor construction. (One indoor plant was built in 1948 in an existing building.)

Over the years we have averaged about one hurricane per year on our system and, depending on the path of the storm, one or more plants might be affected. The older indoor plants have, of

¹² Superintendent of Generating Stations, Florida Power & Light Company, Miami, Fla. Mem. ASME.

course, weathered more storms than the newer plants and two of our newer outdoor plants have not yet been exposed to storms of hurricane force.

With the exception of several auxiliary motor failures in two of the early semioutdoor plants, we have had no plant shutdown during hurricanes as a result of design features of either indoor, semioutdoor, or full-outdoor construction, and our operating experience indicates that the three types properly designed are equally reliable under hurricane conditions.

The last hurricane affecting our system occurred in October, 1950, when three plants in the Miami area were exposed to winds approaching 125 mph. Four outdoor units, one semioutdoor unit, and five indoor units were involved. All three plants are on, or near, the ocean and there was considerable wind-driven rain and salt spray. One plant was shut down by salt spray on the outdoor switchyard which, though protected by a nearby building, is less than 100 yd from salt water. The other two plants continued to operate, though at reduced load occasioned by loss of transmission and distribution lines.

In the earlier versions of the outdoor plant, it was necessary to adapt much equipment for outdoor use, such as turbines, exciters, motors, instrument panels, etc. Co-operation between the designer and manufacturers has eliminated the need for adaptation and, in general, equipment for outdoor use is readily available today.

We have several types of enclosure for the turbine and generator, but as a result of our experiences have now standardized on small walk-in enclosures for the governor end of the turbine and the exciter end.

C. W. GEUE.¹³ The request for information on operating difficulties with outdoor plants in dust storms posed a problem, since we found it difficult to discover any serious cases of trouble that could be traced to dust storms. From three to five years of experience with outdoor steam-electric generating stations in West Texas, during one of the worst droughts in history, has definitely shown that no serious operating or maintenance problems are caused by dust or sand storms. It is very likely that had these stations been completely enclosed, the dust and sand nuisance would have been worse, since dust and sand would have accumulated in the enclosed areas.

Aside from the nuisance of these dust or sand storms we have not found any distinction between operating an indoor or outdoor plant under these conditions. The key operators are in an air-conditioned control room and others are in sheltered areas. Clear glass goggles are available to assist operators in seeing properly while inspecting equipment during a severe sand storm.

Good housekeeping is necessary in any plant whether indoors or outdoors. The following minor problems have come up in outdoor stations which would also occur in an indoor type of plant located in areas where dust storms are prevalent:

- 1 Leaky oil seals on motor bearings will result in an accumulation of oily dirt on the motor windings. Pressurizing these seals eliminated the problem.

- 2 Grease and oil on valve stems, regulator-valve stems, and reciprocating pump shafts, etc., will catch sand or grit and result in more rapid wear and leaky packing.

- 3 Some sparking and more rapid wear of brushes on commutators and collector rings have been noted during severe sand storms, especially so in one case where a high wind blew dust into the exhaust-air duct from the exciter hood. This was corrected by modifying the exhaust outlet. Protection of exciters is such that they are as well enclosed as in indoor plants and the dust

¹³ Superintendent of Power, Texas Electric Service Company, Fort Worth, Texas.

nuisance has not had any more effect on this equipment than if the machine had been indoors.

4 During maintenance, severe dust storms may stop work on exposed machinery, which must be covered to protect bearings, journals, and open oil lines from sand. Careful cleaning of such parts afterwards is very important.

5 Auxiliary power-switch cubicles should be made dust-tight.

Summarizing our experiences, we have not had any operating problems that could not have been prevented by good house-keeping.

H. G. HIEBELER.¹⁴ The Houston Lighting and Power Company is now operating at two plants six completely outdoor unit installations totaling over half a million kilowatts in capability, ranging in size from the two 60/66 mw preferred standard machines which went into service at Greens Bayou in 1949, to the two 80/100 mw units completed there this year. In addition, there are on the system four outdoor steam-generator installations of 135-mw total rating serving two indoor and two semioutdoor (covered) turbine-generators. The first of these, a 25,000-kw unit at the Gable Street Station, has been in service almost 15 years and one at another plant for over 10 years.

Under construction or in design are four major capacity additions, two 80/100 mw units for the new Webster Station scheduled for initial operation in 1954 and 1955 and two 125/156 mw Joppa-type reheat machines, one for completion in 1955 as an addition to the Deepwater Station, and the other for 1956 for the new Sam R. Bertron Plant. All, with the exception of the Deepwater extension, will be of completely outdoor design. The Deepwater machine will be installed in an extension of the present turbine room in order to utilize existing crane, circulating-water tunnels, and other facilities, and to simplify operation of the combined plant. The steam generator and its auxiliaries will be outdoors.

When this expansion program is completed in 1956 total outdoor plant capability will approximate 900 mw and the outdoor boiler plant 1200 mw. All of the newer and about 85 per cent of total system boiler capacity will be outdoors as well as almost 60 per cent of the total installed turbine-generator capacity of one and a half million kilowatts. The reliability of the outdoor plant has necessarily been carefully considered by our engineers and operators.

While the mild climate of South Texas may be thought more favorable to outdoor operations than that of other sections of the country, changes of weather there are often sudden and accompanied by squalls with high winds and driving rain. The warm southerly winds from the Gulf contribute high humidity and, at certain seasons, fog. Heavy tropical deluges are not infrequent and annual rainfall is in excess of 40 in. Hurricanes occasionally whip through the area.

The operating experience with the outdoor equipment has not been substantially different than that at the indoor stations. A few failures of splashproof motors in outdoor service have been experienced due to moisture; but on all installations prior to 1950 the only motors available were inadequate adaptations of indoor designs. Details of the difficulties in this regard have been previously reported.¹⁵ Manufacturers have developed and now offer greatly improved weatherproof designs for outdoor application with well-protected ventilation openings, air filters, and adequate heaters.

To combat dampness and prevent condensation on sudden atmospheric temperature changes, all outdoor motors are pro-

vided with heaters to be turned on when a motor is not in service. Some of our motor troubles are believed due to the operator's failure to observe this precaution where this operation is a manual one. However, similar protection is also required or desirable in our climate for motors and electrical equipment in all but a few locations even in the indoor plants.

Since the heaviest loads and highest outputs of the system come in summer due to air conditioning, irrigation pumping, and other seasonal loads, the maintenance falls into an October 15 through mid-May period. This usually involves some cold and rainy weather which may slow the work slightly but has never stopped it. The majority of these days are actually the most favorable of the year for outdoor activities.

An unscheduled test of the ability to do maintenance under extreme weather conditions developed when on January 29, 1951, a generator-coil insulation failure occurred on one of the 60/66 mw units at Greens Bayou. This was not due to outdoor operation. The wet freezing sleet "Norther" on at that time continued over 120 hr to establish the longest continuous period of subfreezing temperatures ever reported by the Houston Weather Bureau. During that time, under protection of a temporary tarpaulin-covered canopy, the exciter and generator-end bells were removed and the field was pulled to allow examination of the windings. Sleet, coating the trolley wires of the gantry crane, delayed work several hours. The generator was down about four weeks for replacement of 18 coils. The work proceeded day and night under tarpaulin covers with space heaters being used to prevent sweating. As this difficult job was accomplished under the most adverse conditions the operators are now confident of their ability to handle any foreseeable future maintenance problem.

The completely outdoor plants here have been tested by only one hurricane of comparatively short duration, although the older outdoor boiler units have experienced major storms. Heavy driving rains give frequent fairly complete short-time tests. No difficulties have been experienced. Of course, the indoor stations during a tropical storm are not exactly as snug and tight as those who have not enjoyed such experience might imagine. Large ventilator windows necessary for summer cooling are almost impossible to make tight against rain and 100-mile winds, and in consequence water may be showered down on equipment not designed for such contingency.

Some extra and more frequent painting is required by the outdoor plant if protection and appearance are to be maintained. Valve stems and similar parts present corrosion problems. The extra costs here are offset by building and roof-maintenance savings.

The individual operators and maintenance workers generally prefer assignments at the outdoor stations. The supervisors also favor these plants. When comparing semioutdoor, completely outdoor, and the outdoor units with walk-in turbine-end enclosures, all of which we are operating, there is practically 100 per cent preference in all ranks for the totally outdoor arrangement. It was, however, found desirable to add walk-in enclosures over the standard roll-away exciter housings of the original Greens Bayou units although no trouble actually developed from lack of them in three years of operation; and this will be standard practice hereafter.

Our organization has been well satisfied with the reliability of results from, and experience with, the outdoor plants to date. As stated, plans for the future include a 125/156 mw outdoor installation for the new Sam R. Bertron Station. As the first unit there, it defines, in general, the character of future design for this site which our engineers estimate has an ultimate possible capacity of over a million kilowatts. It is believed that above anything else this confirms the satisfaction of our engineers, operators, and the company management with the outdoor plant.

¹⁴ Superintendent of Power, Houston Lighting and Power Company, Houston, Texas. Mem. ASME.

¹⁵ "The Outdoor Power Station in South Texas," by H. G. Hiebeler, presented at ASME Fall Meeting, Chicago, Ill., Sept. 8-11, 1952.

PAUL BLANCHARD.¹⁶ Utah Power & Light has 425,000 kw installed capacity of which 245,000 kw is in steam. It has under construction two steam plants to add 166,000 kw within the next 18 months.

Temperatures in the area average a little over 50 F with a minimum of minus 35 F. The average annual precipitation is 16 in. including an average of 54 in. of snow. Wind averages 8 mph with maximums of over 50 miles per hour. Under such weather conditions, the first outdoor boiler has operated since 1936. Three more outdoor boilers have been completed and two additional ones are under construction.

An outdoor boiler installation materially reduces the first cost of a plant by eliminating a large section of building, together with accessories such as heating, ventilating, and cleaning equipment. Operating costs are reduced by eliminating building maintenance and power for heating and ventilating equipment. Savings exceed the additional cost of an outdoor boiler with the necessary weather protection, such as steam or electric tracing and water-proofing. The convenience and accessibility of an outdoor boiler outweigh any disadvantages due to inclement weather. Personnel have been well pleased with operating conditions.

With all the advantages just mentioned, there are still some difficulties that must be solved before satisfactory operation can be maintained.

Freezing weather is the principal problem encountered. In subzero weather safety valves, blowdown valves, water columns, air lines, control lines, and many drain lines, have frozen at one time or another, even though every effort had been made to have these items insulated and traced.

The results of a good stiff breeze in subzero weather are unpredictable. Water columns have been frozen within 2 ft of a steam drum even when heavily insulated. Any openings in the protective covering may result in frozen lines even when tracing is in service. Steam escaping from a safety valve or vent line can be condensed and frozen so fast that the vent can actually be sealed closed.

Steam or electric tracing is used on all accessory equipment. Steam tracing is usually turned on and off seasonally. Some tracing lines vented to atmosphere are controlled by throttling to keep a small plume of steam at the end of the line at all times. This system is generally used with small $\frac{3}{16}$ or $\frac{1}{4}$ -in. copper tubing on short runs where the operator can see the end of the tracing line from the control point.

Other tracing lines are drained by means of a steam trap. Such systems are generally used with $\frac{3}{8}$ to $\frac{1}{2}$ -in. copper tubing and impulse traps. An impulse trap has a safety feature in that it usually fails in an open position. Care must be taken to avoid pockets where condensate might collect and freeze.

Electric tracing cannot be used on drain lines from superheaters when high temperatures are encountered during part of the time. Electric tracing is generally easier to maintain than steam tracing and has the added advantage that at very little cost a contact-making thermometer can be used to cut it on or off automatically at any desired temperature.

Large lines, 6 in. and over, are usually protected by spiraling copper tubing or heating cable around the pipe inside the pipe covering. Smaller lines can be protected by paralleling the pipe with the heating element. Lines, 1 in. and under, can often be grouped and wrapped with a spiral heating element and then the whole group enclosed in a pipe covering of an appropriate size. Care must be taken to see that control lines requiring constant head, such as water-level controls, are not in contact with some hot drain line that would affect the water density. Variations in boiler-water level due to this phenomenon have occurred.

¹⁶ Manager of Steam Plants, Utah Power & Light Company, Salt Lake City, Utah.

Control air is carefully dried so that freezing due to condensation is reduced to a minimum.

Electric space heaters are used to protect a full boiler when it is down for maintenance during freezing weather and it is necessary to work in the gas passes. Electric strip heaters are used in totally enclosed motors and in pneumatic controllers to avoid condensation and freezing.

We are thoroughly satisfied with outdoor boilers and have had no insurmountable problems due to the outdoor installations.

R. A. REM.¹⁷ The F. W. Bird Plant of The Montana Power Company at Billings, Montana, is the farthest north of any outdoor plant built to date. The plant went into operation on December 1, 1951. An outdoor plant embodying the design features of this plant is satisfactory for the severe climatic condition of the Montana area.

There have been very few instances where working conditions would have been improved by having the boiler and turbine enclosed, and after two years of operation we feel additional expenditure for enclosure would not be warranted. From an operating standpoint, the personnel prefers the outdoor boiler because of reduced heat, less noise, and fewer cleaning problems encountered. The fact of the installation being outdoor type has not affected the operator pay scale or required additional operators under any conditions experienced—in fact it is believed that with the outdoor design fewer personnel are required. Normal maintenance has not had to be deferred because of weather conditions so far. Major outages are scheduled during mild weather. Although during overhaul of the turbine there could be times when certain phases of the work might have to be postponed for a short time due to inclement weather, there usually is enough other work going on so that the outage schedule would not have to be prolonged by having to wait for the weather to improve.

On the point of the relative cost of maintenance in comparison with an indoor plant, we doubt if cold weather, while admittedly disagreeable, is much of a handicap or that it increases the maintenance cost. Men are more productive in cold weather than under hot conditions. The cost of rigging canvas enclosures is not excessive, due to sufficient structural steel members around the boiler from which temporary enclosures can be hung, such as for soot-blower maintenance, and the like. As for maintenance inside of the boiler proper, the stored heat is sufficient for two or three days' work even in the coldest weather. Outdoor painting costs may be increased somewhat but probably will be offset by the fact of not having extensive turbine and boiler enclosing structures to paint.

Inasmuch as this plant was the first one designed for the Montana weather conditions, which have the most extreme temperature conditions of any outdoor job to date, initial troubles were experienced at a number of points, which have been corrected. The principal items of this kind were:

Trouble was experienced with retractable soot blowers due to inadequate piping drainage coupled with insufficient heating cable and pipe insulation. The piping drainage was modified and additional electrical heating added.

Trouble was encountered during winter months with traps freezing up. The fuel oil lines to the day and oil storage tank are steam traced. The line also furnishes steam for the suction heaters and floor heating coils in the main storage tank. The traps and return lines were exposed with the condensate going to waste. Frozen traps had to be thawed with blow torches.

The drains from the boiler safety valves were originally piped several feet. In mid-winter these drains froze and ice formed on the discharge side of the safety valves, making them inoperative.

¹⁷ Superintendent of Generation, The Montana Power Company, Butte, Mont.

The drains were shortened so they now contain no more than one short nipple and an elbow, which solves the problem. This difficulty could occur on an indoor design.

The forced-draft fans are installed in a plenum chamber with Aerofin sectional coil-type heating coils in the walls. During the first winter season about 150 leaks occurred as a result of frozen tubes occasioned by improper condensate-return piping. The condensate returns from all heating coils, unit heaters, and auxiliary headers terminate in a common condensate tank. Leaky traps caused pressure to build up in this tank which, in turn, retarded the free flow of condensate from the heating coils. This piping has been changed to eliminate the back pressure.

For prolonged shutdowns in cold weather, the boiler is completely drainable, but when it is desired to leave the water in the boiler, salamanders are used to maintain temperatures above freezing. Stand-by electric power is necessary to supply electric tracing and to operate the gas-fired house boiler used for building heat, tracing on the condenser hot well, and instrument piping tracing. Because of limited capacity of the house boiler, equipment taking load from it must be operated at reduced ratings.

Flue gas-sampling lines to the orsat froze on occasions when temperature dropped to the dew point. Considerable trouble was experienced with this until an electric air heater was installed which blows heated station air through the orsat lines back into the boiler when they are not in use sampling gas.

The control valve which admits steam to a heater jacket to control the fuel-gas temperature to the gas-metering house became inoperative during cold weather because it used steam as a valve-operating medium. It has been replaced. The new type uses gas as an operating medium.

The outdoor Foster-Wheeler steam generator has heated walk-in enclosures at each end of the single boiler drum. Instrument piping from the drum to the firing level is enclosed in insulated ducts containing the water column and gage-glass drains, drum-level indicator, recorder and controller lines, drum-pressure gage line, continuous blowdown and water-sampling lines, steam-sampling lines, and chemical feed line. The ducts are heated by radiation from the steam supply and condensate return lines of the unit heaters in the walk-in drum enclosures. A freeze-up occurred when the unit-heater blowers were inadvertently left off. This damaged a bourdon tube of the drum-pressure gage. The feedwater control was put on hand until the ducts could be heated and the lever controller was again made to function.

Cold air pulled through a building vent in the cable vault under the control room froze some instrument lines. This has been remedied by closing off the outside vent.

The soot-blower steam pressure-reducing station is located in the forced-draft-fan room and has a Fisher valve for pressure reducing. This regulator froze during an outage in mid-winter causing the bourdon tube in the controller to rupture. In case of future subzero outages, the normal air inlets through the heating coils will have to be covered with tarpaulins, and this area heated either from the main building with salamanders or with unit heaters.

The induced-draft-fan inlet and outlet damper-control drives and fuel-gas control valve are located outside. The control air lines to this equipment are unheated and depend upon the silica-gel to maintain the dew point below ambient. One case of icing in the induced-draft-fan inlet damper-control-drive pilot valve caused faulty operation. This will be overcome by additional heating of the silica-gel in the air driers. The composite drain header from superheater, economizer, and extended surface-boiler headers froze because it was unprotected. It had to be thawed with blow torches. Damage to the superheater tubes could result from this type of freezing in case of loss of load.

Considerable difficulty was experienced with the induced-draft-

fan inlet and outlet dampers due to sticking. The original design and the cold temperatures encountered were contributing factors which caused corrosive flue-gas deposits to build up between the damper shaft and bearing spacer causing the vanes to bind. The damper shaft became immobile to such an extent that drive arms were bent on a load rejection and the connecting shaft between dampers sheared all universal bolts. The trouble was remedied by removing the pipe-bearing spacer and substituting a stuffing box with two rings of packing.

Expansion joints in the exit-gas ducts show signs of considerable corrosion. These are uninsulated and consequently in cold weather severe condensation is experienced. It is planned to insulate or heat these joints in question.

The first winter's operation of this first steam plant on a previously all hydro system presented some difficulties for operating and maintenance personnel with no previous steam experience. However, an outdoor plant in this climate is practical. The problems encountered were mainly due to lack of previous design experience for Montana weather conditions and operating inexperience. It is believed that our difficulties have been overcome.

T. M. MORONG,¹⁸ C. T. EYRING,¹⁹ AND J. O. RICH, JR.²⁰ The Southwestern location of our system, in a region having around 300 days per year of sunshine, led to the early consideration of an outdoor design. After a year and a half of operation, the decision to construct Kyrene as an outdoor plant has been well justified from all major aspects of design and performance (Fig. 15).

The basic thought underlying the design was to erect a plant for the optimum ultimate economy. Consideration was also given to the extremes of temperature in this locality, the range at times being from 20 to 120 F. Direct radiation during the summer increases the upper limit of this range to 140 F. Periodic rains of torrential intensity and heavy dust storms also shaped our thinking.

All the recognized advantages of outdoor construction were realized at Kyrene. A savings of \$6 to \$7/kw resulted from the outdoor construction. A 50 per cent decrease in operating personnel was realized over an older installation of slightly smaller capacity. This latter fact is attributed to the two main features of the plant: (a) Compact arrangement, yet with ease of accessibility to all of the equipment; and (b) the use of completely centralized instruments and controls.

*Plant-Design Features.*²¹ The main plant design departed slightly from a completely outdoor design, the first of these departures being a curtain wall enclosing all of the major auxiliaries below the turbine deck. This curtain wall is of lightweight concrete block, reinforced for earthquake resistance. Such an arrangement provides adequate climatic protection, both from rain and dust. It also assured a minimum building volume for the plant. Several other advantages resulted from this design. We were able to use standard indoor equipment, both for auxiliaries and auxiliary drives. It was also possible to eliminate the necessity for exterior administration and service buildings on the site. The superintendent's office and control room are located on the turbine deck. Mechanical, electrical, and instrument repair rooms and laboratory are all included in the enclosed structure under the deck. Air washers are used to provide cool dust-free air to the interior of the enclosure, resulting in an extremely clean and dust-free plant, since there are no below-deck

¹⁸ Chief Engineer, Salt River Power District, Phoenix, Ariz.

¹⁹ Assistant Chief Engineer, Salt River Power District, Phoenix, Ariz. Mem. ASME.

²⁰ Superintendent of Steam Plants, Salt River Power District, Phoenix, Ariz. Mem. ASME.

²¹ Plant descriptions in *Combustion*, October, 1952, and in *Electrical West*, August, 1952.

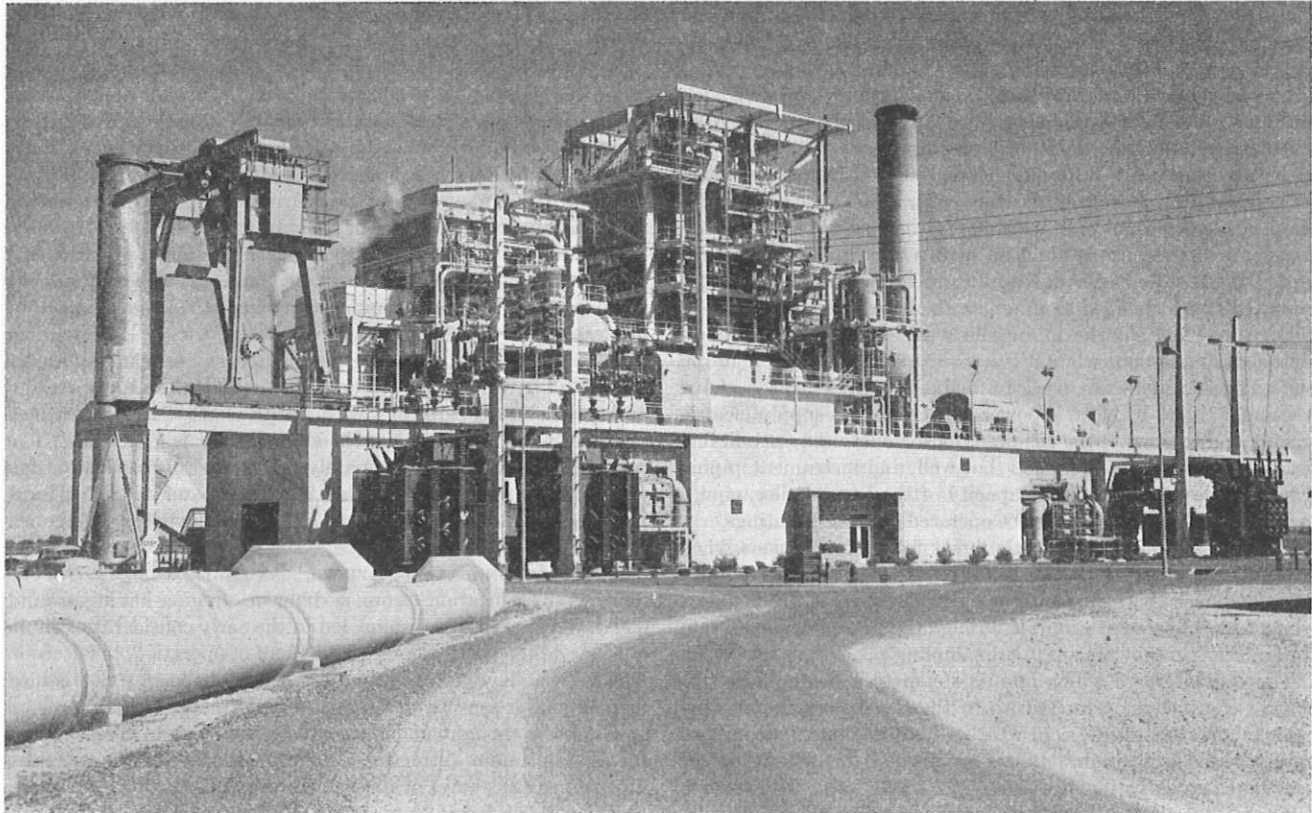

FIG. 15 KYRENE—OUTDOOR STEAM PLANT OF SALT RIVER POWER DISTRICT

windows. This enclosure also gave us the advantage of better maintenance conditions for the day-to-day work on station auxiliaries.

The boiler firing aisle is at the deck level adjacent to the control room. It is completely enclosed for climatic protection.

The 30,000-kw turbine-generator located on the deck or roof of the enclosure has the control end of the turbine in a steel house. The balance of the turbine and the generator are the manufacturer's standard outdoor design. This particular arrangement was the intermediate design of the manufacturer prior to the completely outdoor turbine. Delivery problems prevented our use of a completely outdoor design. A second unit, rated at 60,000 kw, is now under construction at this location. Its turbine-generator is a complete outdoor design.

Operating Experience.

Below Deck Enclosure.

The small below-deck enclosure has shown itself to need considerably more ventilation than would normally be required in a volume of this size. The incoming heat load per unit volume is high with much radiant pickup from windows and building walls, as well as from the boiler and other thermal vessels. The ventilating-equipment duty is therefore higher than would be needed in a conventional power building. High ambient temperatures were experienced in the switchgear room and resulted in some relay trouble. Additional ventilation of the switchgear was required to correct this. The operators experienced some discomfort in going from a completely air-conditioned control room at 70 F into a station ambient of 100 F. The station hot spot proved to be a stair well with several windows at the top.

These problems were solved by the installation of additional ventilating equipment and by the removal of some windows to decrease the radiant-heat load. This latter move is, of course,

effective only in the summertime. But this is, of course, the period of the highest solar-heat load.

Turbine Enclosure. The present housing has proved inconvenient during repairs. It is difficult to dismantle and re erect at time of turbine outages. Valuable lay-down space is required to store it at such times. The enclosure requires considerable forced ventilation and adequate air filters to maintain any degree of cleanliness. As previously mentioned, the second unit now being installed at this station has no such enclosure.

Enclosed Firing Aisle. The aisle is small in volume with a high ambient temperature. There is a great deal of radiation from the burner fronts. It was found necessary to increase the ventilating equipment and the rate of air change in the area. A more adequate form of boiler-front insulation is required. We feel the advantages of the enclosed firing aisle outweigh any of the disadvantages mentioned here.

General Operating Experience. Anyone designing and building an outdoor plant should give considerable attention to the sealing of combination slabs used both as a floor and a roof. If insulation is used under a wearing deck on a roof slab, such insulation should be rigid, such as perlite concrete, foam glass, or a silicate-type insulation. All construction and expansion joints should be sealed with a cast-in-place rubber water stop. These joints should be checked periodically for deterioration and kept well calked.

The outdoor installation of our chlorinator presented some problems because it was basically an indoor type. Extreme climatic temperature changes resulted in some reliquefaction and damage to the expansion-valve seat. Additional insulation of exposed lines corrected this problem.

Painting this type of plant in our Arizona climate also has its problems. Thermal vessels subjected to internal heating have a short paint life when exposed to direct sunlight. We are still

experimenting with a number of paints as a means of solving this problem.

Weatherproof pipe insulation was used on all exposed piping. Repairs to the weatherproofing must be made as soon as the trouble is noted. The deterioration of the inner insulation is rapid once the weatherproofing is broken.

It was found necessary to acoustically insulate the main gas line where it passes adjacent to the chemical laboratory. The small building volume also resulted in some uncomfortable temperatures in an office adjacent to a pipe chase. Increased ventilation of the chase corrected this.

During major turbine outages, it is necessary to secure and protect all dismantled parts to a greater degree than would be required in a conventional station.

We have found that the extreme-temperature variations have resulted in more colds and an increase in time off for operating personnel, over an older conventional installation.

The operators' satisfaction, however, is very high at this plant. Operators have turned down chances for advancement when such advancement required their returning to an older conventional installation. Supervision at the plant also feels very satisfied with the design and operating experience to date. We have also had a good reaction from our maintenance personnel, working both indoors and outdoors at this location.

Management is well pleased with the operating experience and costs at this plant. It is convinced that the curtain-wall protection of auxiliaries is paramount for successful operation of outdoor plants, rather than the somewhat stylized refinery-type outdoor plants in other locations. Satisfactory operation also requires adequate supervisory instrumentation for remote checking. It is also felt by management that the cost of adequate centralized controls has been well worth the investment in reduced personnel requirements. The fact that we are building a second unit of this type is good evidence of our over-all satisfaction with outdoor plants.

J. A. INWRIGHT.²² Four units are in service at Sewaren; two went in service in 1948 (one in November and one in December), one in October, 1949, and one in July, 1951. The units are as follows:

- No. 1—110,000 kw
- No. 2—110,000 kw
- No. 3—110,000 kw
- No. 4—125,000 kw (reheat)

Each is served by its own boiler with no cross connection between units.

The boilers are of semioutdoor construction. The furnaces are all indoors. Part of the superheaters and the remainder of the gas passages are outside. Certain mechanical equipment is outdoors, such as air preheaters, forced and induced-draft fans, and precipitators. The combustion control is pneumatic. The soot blowers are air-operated, air-controlled. Some of these are out of doors.

With this amount of outdoor equipment, certain conditions must be watched. The air for combustion control and for control of the soot blowers must be dry. Driers remove moisture in the air to insure that there will be no freezing down to -40 F. The air is periodically checked for dew point to make sure of this.

The bearings of the forced and induced-draft fans are air-cooled by drawing outside air through cored spaces around the bearings to the suction side of the induced-draft fans. This has been found to be sufficient.

²² Superintendent, Sewaren Generating Station, Public Service Electric and Gas Company, Sewaren, N. J.

Since the superheaters are of the pendant type and cannot be drained, the temperature within the superheater bank is watched closely during overhaul periods in extreme cold weather. Sometimes warm air is blown into the furnace by erecting a steam coil and blower at the furnace access door.

Oil for use in the outdoor equipment is specified to have the proper viscosity at low temperature. The same oil is used summer and winter and has been found satisfactory for ring-oiled bearings and in the hydraulic couplings.

Most of the time, the outdoor equipment can be easily maintained. At times wind breaks made of tarpaulins have been required to protect the men. It has been found that in extremely cold weather it takes two to three times as long to do close tolerance work such as lining up rotary equipment.

There is a considerable amount of exposed steel which must be painted both for protection as well as looks. Experience with this has been limited because of the short period of service.

In the five years the plant has been running, there has been only one time when the temperature was below freezing for a long period of time. This was in February, 1950, when the average temperature was about 24 F for 12 days. The minimum temperature during this period was 8 or 10 F. An extended outage of No. 1 unit included this period. It was possible to schedule the work so that the effect of the low temperature on the over-all maintenance work was negligible.

Because the forced-draft fans are outdoors the air-heater inlet temperatures are controlled to reduce fouling. This is done by recirculation in three of the boilers and by heating the inlet air with steam in the fourth boiler. When burning oil even with these precautions, the air heaters have to be washed several times a year.

The operators who handle the equipment are stationed inside, but make periodic inspection trips outside and visit each piece of apparatus. The temperatures of the bearings and motors are remotely indicated in the control room.

All in all, for this area and its weather conditions, operation with semioutdoor construction is satisfactory.

J. B. SAXE.²³ This subject is extremely pertinent as it constitutes the most important means of combating the inflationary rise in the cost of power-plant construction. While little can be done to reduce costs in many components of the power plant, engineers have been able to assume control of the situation to a limited degree by minimizing the structure and placing some of the equipment outdoors.

There is no question but that a substantial saving in first cost can be achieved by so doing. The savings will vary widely depending on the basis of the comparison, that is, whether the enclosure to be eliminated is corrugated asbestos or brick exterior and tile interior, but appear to revolve around a figure of \$5 to \$7 per kilowatt of capability.

Even with some increased maintenance and inconvenience, a saving on this order is most attractive. It would therefore be of greater interest, instead of discussion whether equipment should be placed outdoors, to discuss the extent to which it should be placed outdoors.

Examination of the source of the savings reveals that most of the gain comes from placing the boilers and heaters outdoors. In its essence, the saving consists in elimination of the siding and its supporting girts, of the roof, and of the ventilation, less provisions for outdoor operation. The boilers and heaters are the major dissipators of heat and in southern climates it is practically impossible to provide satisfactory ventilation if they are enclosed. The only fully satisfactory means of providing comfort is to elim-

²³ Chief Engineer, Gibbs and Hill, Inc., New York, N. Y. Mem. ASME.

inate the enclosure. In locations of considerable precipitation, it is necessary to build and take down a temporary roof over the boilers during construction. Since the cost of this operation very nearly approaches that of a permanent roof, the construction of the latter is more logical. In northern climates, enclosure of the steam drum still appears desirable. The oil industry has employed plastic casings outdoors with results that would not be considered acceptable by the utility industry. If a plastic casing is acceptable when enclosed and steel-cased setting necessary outdoors, a substantial portion of the saving disappears. However, there are now some plastic settings on outdoor installations which show promise of considerable permanency and it is questionable whether such a difference is proper in the comparison. Even in the severest climates, there appears to be little justification for enclosing dust collectors, induced-draft fans, and tanks. In cold climates, facing a hot casing with winter on the back while handling a furnace is not conducive to good health of the operator. In such locations, particularly liberal furnaces and ample means for cleaning the furnace from a more comfortable spot are important. With the introduction of furnace television, a great many operations formerly conducted manually at the burners can now be conducted safely, remotely from the control room, and enclosure of the burners if located at the rear of the boiler no longer appears necessary. Electrically driven and controlled soot blowers appear to be superior for outdoor installations. The problem of cold air on the cold end of the air heater appears to have been satisfactorily and economically solved by introduction of the steam air preheater. While some of the outdoor boilers in northern climates have not yet experienced a really severe winter, many of the problems have been solved and such an installation appears feasible and economically attractive.

While considerable structure is eliminated in placing the turbine outdoors, the saving is relatively small due to the high cost of the gantry crane and walk-in housings. So far, attempts to lower the cost of these two elements have not been very successful. Also only a relatively small amount of heat is dissipated in the turbine room and the ventilation necessary is not very costly. In warm and arid areas, the taking of this relatively small saving appears to be amply warranted, particularly if the climate is being promoted and the utility is part of the act. However, in the colder and higher-precipitation climates, the operators are inconvenienced, and to some extent maintenance costs are increased and outages prolonged so that the question as to whether the saving should be taken is much more debatable.

The problems involved in protecting instrument and control lines against freezing appear to have been solved satisfactorily. Some outdoor installations have experienced excessive repainting costs. More attention should be given to this subject and to the use of materials which do not require painting.

M. D. ENGLE,²⁴ Present economic conditions require that we find ways to continuously reduce the unit cost of the facilities required to supply electrical service to our customers. This, of course, applies to all facilities, generating stations, transmission, distribution, and service facilities.

While it is true that over the past years we have done a good job in increasing the thermal efficiency and reliability and in reducing the number of men required to operate and maintain our generating stations, this is not enough. Even though our present-day stations, with all these improvements, cost less per kilowatt of capacity than the stations of years ago, when we correct the present costs for the lower value of our dollars, it is still not good enough in view of the fact that our income is in present-day dollars which are not corrected for inflation. We must retain

²⁴ Mechanical Engineer, Pennsylvania Power & Light Company, Allentown, Pa. Fellow ASME.

and improve upon these achievements of the past and at the same time find ways to reduce the unit cost of construction.

As our interconnections are increased in capacity we should take full advantage of the possibilities and economics of larger and larger units. Staggered construction between interconnected systems and proper short-term firm power contracts should permit economical financing of the larger-size units.

The adoption of the outdoor or semioutdoor design of generating station also should help materially in finding a way to construct the generating stations at a lower cost per kilowatt of capacity and many companies are proceeding along this line.

In these semioutdoor stations, by proper design, all of the equipment which needs "walk-in" enclosures can be enclosed in low unit-cost enclosures, and most of the operating personnel also will be located inside.

Feedwater regulators, hp heater drainage controls, evaporator drainage controls, and other similar equipment, sometimes installed out of doors in such stations, can just as well be located inside.

However, there are many other features of design which should be considered seriously and should further reduce the unit cost of construction. Some of these are as follows:

- 1 The turbine-room basement should only be as far below grade as necessary to obtain an economical foundation below the turbine-room mat. Many studies have shown that it is not economical to lower the condenser just to reduce the head that must be developed by the circulating-water pumps. Neither is it economical to raise the condenser basement to the operating grade just in order to have it at that level.

- 2 If the level of the condenser above the water level in the river is such that a siphon cannot recover all of this difference in level, then the head which must be lost can be utilized to force the water back to the river at a higher velocity through a smaller than normal discharge conduit and a worth-while saving in the cost of construction can be obtained.

- 3 When the condenser is located closer to the operating grade, the intake and discharge tunnels do not need to be as far below grade and consequently cost less to install.

- 4 Reinforced-concrete pipe in place of "formed-in place" concrete tunnels are usually less expensive.

- 5 Most of the industrial buildings constructed today are of concrete block. Good-quality concrete blocks have demonstrated that they have a long life and are a satisfactory and economical material of construction. It would appear logical therefore that concrete blocks should be considered seriously for the principal buildings and enclosing walls at a generating station.

- 6 Reinforced concrete silos with offset conical bottoms have been used as coal bunkers for many years and have been found very satisfactory. They are more self-clearing than rectangular bunkers, they are cheaper per ton of coal stored, and they also can support the coal conveyers and housing above them. It would appear that the reinforced-concrete silo is the logical type coal bunker for coal-fired steam-electric stations.

- 7 While tile floors for turbine rooms and boiler rooms are much better looking, concrete floors are less costly.

- 8 A porous crushed-gravel surface for the station yard is low in cost, areas that settle can be filled to grade cheaply, and rain water can usually be allowed to seep into the ground below without requiring an expensive pipe drainage system. It would appear that the same type of gravel surface should be suitable below the outdoor boiler instead of the concrete pavement frequently provided.

- 9 A large-capacity caterpillar crane can be used at outdoor stations for many purposes in place of permanent steel structures and hoists. Some of these are as follows:

- (a) Lifting intake bar racks and screens.

- (b) Installing and removing stop logs at intake and discharge structures.
- (c) Lifting rotors and motors of ID and FD fans.
- (d) Overhaul of outdoor pumps and motors.
- (e) Repair of bulldozers and carryalls and locomotives.
- (f) Repair of car dumpers and coal grids.
- (g) Maintenance of transformer and OCB bushings.

10 The outdoor steel standpipe, supported at grade, has been found to be an economical means of water storage by most all municipal water supply systems. It would appear to be the most economical means of storing service water and condensate at steam-electric stations. A fire pump can be installed for any higher pressures required.

11 A single-track hopper for unloading railroad cars and reclaiming coal from storage can usually be used instead of separate pits for the two purposes.

12 A recent survey has indicated that the capacity to unload railroad cars by means of a "car shakeout" is usually limited by the capacity of the hopper provided. By installing a track hopper of adequate capacity, the large investment for a car dumper might be delayed a number of years or omitted at a new station.

13 Where the ash-disposal line is not too long, the jet pump is lower in first cost than motor-driven ash-pump installations.

14 A single three-phase step-up transformer for the main generator is considerably less expensive than three single-phase transformers and operating experience indicates that the additional cost of the single-phase transformers and a spare cannot be justified.

15 Service at 4000 volts to the larger auxiliary motors results in lower cost than 2300 volts.

16 A single 4000-volt bus for each unit seems to be in keeping with the unit construction used elsewhere in station design. The economics of a second or third auxiliary bus bears careful scrutiny.

17 Some studies have shown an engine-driven fire pump less expensive than a separate source of electrical service.

These few examples are presented only as an indication that even after we adopt the outdoor or semioutdoor design of station, there are still many features of design that may be changed to reduce further the unit cost of construction. It can and must be done.

M. K. DREWRY,²⁵ Cost reduction appears the single impelling urge of omitting enclosures. Evaluation of cost reduction is therefore vital.

The investment savings in omitting a typical brick wall costing \$3.50 per sq ft contrast importantly with the investment savings when omitting asbestos-cement siding costing 70 cents per sq ft, only 1/5 as much. That outdoor design should be compared with minimum-cost practical enclosures seems obvious.

Asbestos-cement siding ("corrugated transite" is one name for it) has been found to be a practical and desirable boiler-room enclosure. For turbine-room enclosure, 1 in. of insulation can be justified, causing doubling of the 70-cent cost to \$1.40 per sq ft, erected. These costs obviously do not include supporting steel, to be treated later.

Twenty-five years' experience in an unfavorable environment has proved this material of practically zero maintenance and of continued good appearance. The asbestos fibers and the particular siding design result in a concrete that is more nearly permanent than even typical concrete.

With a maintenance-free weatherproof enclosure protecting the great area of all boiler-room and turbine-room surfaces, some of

²⁵ Chief Engineer of Power Plants, Wisconsin Electric Power Company, Milwaukee, Wis. Life Member ASME.

which are of high maintenance when exposed to the elements, long-time structural maintenance costs reach a minimum.

Boiler casings, containing flue gas of 100 F moisture dew point and with corrosive sulphur compounds that condense at higher temperatures, though protected to a degree by brickwork and insulation, seem vulnerable to the low metal temperatures of the outdoors. Walkways and platforms of open grating to avoid snow shoveling and cleaning need to be galvanized or equally corrosionproofed to qualify for reasonable maintenance. Painting of all surfaces needs to be more frequent than for indoor equipment. Thus there seems a good probability that asbestos-cement enclosed plants will prove of considerably lower structural maintenance than will outdoor ones.

Construction time and temporary construction sheltering during winter weather are importantly related to outdoor construction, at least in the northern states. Experience proves the need of sheltering workmen and equipment during construction if erection is not to be delayed substantially. The added time of erection can vary markedly, which precludes stating any estimates, but possibly some readers are acquainted with 50 per cent erection labor efficiency resulting from half the time being spent in men warming themselves during coldest weather conditions. In a recent 120,000-kw installation, \$100,000 direct saving in using asbestos-cement siding instead of brickwork was augmented by very approximately an equal indirect saving because of greatly more rapid siding erection permitting enclosure before coldest weather. Delays in starting new apparatus are usually very costly.

Heat saving resulting from boiler-room enclosure pays investment charges of a substantial share of low-cost shelter. The boiler-unit heat-loss difference of indoor and outdoor construction of the foregoing case is estimated at 3/4 per cent of the boiler thermal output. The resulting net coal-cost difference is estimated at 1/4 per cent assuming that this 3/4 per cent greater heat loss of the outdoor boiler plant would be replaced by steam extracted from the turbine after doing 2/3 of the work it would do otherwise. In the case mentioned the capitalized value of 1/4 per cent is \$75,000, or 94 per cent of the cost of the boiler-room siding, its supporting steel, windows, and roof, as follows:

BOILER-ROOM ENCLOSURE COSTS	
Corrugated asbestos siding.....	\$27,000
Structural steel (roof purlins, horizontal girts, and vertical girt posts).....	30,000
Aluminum-frame windows.....	6,300
Aluminum coping.....	2,200
Monolithic concrete roof and parapet walls....	8,000
Roofing.....	6,600
<hr/>	
Total net cost of enclosure.....	\$80,100
Heat saving value of enclosure.....	\$75,000 (94% of \$80,100)

Wall and roof supporting steel is usually integrated with boiler unit, access, and other steelwork, minimizing its incremental cost. In the case cited practically no columns or beams could be omitted upon omission of siding and roof, whereas outdoor construction necessitates many compensatory extra costs.

Simply the boiler-room comparison is cited because there seems no adequate inducement to take the long chance of needed turbine maintenance in mid-winter in this climate without complete turbine-room shelter.

That outdoor construction is a necessary defense against destructive turbine-oil fires may be stated in favor of omitting shelter. However, in the foregoing case, shelter costs include favorable isolation of the oil system of each unit, effectively permitting other units to continue in service and helpfully providing adjacent walls through which to fight the fire. That this isola-

tion system solves the problem better than does outdoor construction seems a fact.

Outage time is usually impressively expensive. An extra day per year of the unit mentioned is as costly as \$60,000 added investment. Thus, if unfavorable weather prolongs outages a total of $1\frac{1}{3}$ days per year, the \$80,100 incremental cost for roof and walls can be paid, with the heat saving as computed left as a net gain.

That the question of indoor-versus-outdoor power plants is one of geography and circumstance probably will never have a simple answer is suggested. For northern states our company's experience suggests that inexpensive shelters are well warranted. Heat savings paid 94 per cent of their cost in a recent case. The substantial gains of importantly facilitating construction and maintenance that enhance the availability of the expensive apparatus are net savings of no little magnitude.

E. C. GASTON.²⁶ The Southern Company system embracing Alabama Power Company, Georgia Power Company, Mississippi Power Company, and Gulf Power Company will by the latter part of 1955 and since 1949 have completed 37 new steam-generating units with a total capacity of 2,234,000 kw.

Although this system is located in an area where it might be generally expected that outdoor or semioutdoor designs would be employed, this has not been the case. At only one location has this type of construction been employed, namely, at Albany, Georgia, which is in the south-central part of that state. At this location two 22,500-kw units are installed in one plant, utilizing a semioutdoor type of construction where the boilers only are located outdoors. This plant was constructed in the 1947-1949 period.

A number of considerations may explain why the outdoor or semioutdoor type of plant has not been employed more frequently in the plant designs on this system. In the first place, it is a combination hydro and steam system, the ratio of capacity being approximately 25 per cent hydro and 75 per cent steam. The annual wet season generally occurs in the early part of each year. Likewise, seasonal load variations are such that the system load is lowest in this same period. Because of this particular combination of factors, the plant outages for maintenance must generally be scheduled during the first five months in each year.

Owing to the large number of units now installed and because of an established practice of removing turbines for inspection every two years, there is a large number of units which must be inspected each year and this fact makes it necessary to plan and schedule these outages with accuracy and with requirement for minimum amounts of time for each unit. Since the outages must be scheduled during the rainy and colder season of the year, maintenance work can be more efficiently accomplished and more quickly completed where it can be performed inside the protection of a building.

Because the system covers a tremendous territorial area (approximately 113,000 sq miles) with plants scattered throughout the area, there are wide variations in fuel and operating costs between the individual plants. Fuel costs may vary from a low of less than 15 cents per million Btu to a high of more than 30 cents per million Btu. When a low-cost unit is down for inspection, the energy which it would have produced must be supplied from other and higher-cost sources. It is therefore most important that outage time be limited to only that time which is absolutely essential for maintenance, since an increase in outage time could involve costs of \$1000 to \$3000, or more, per day for displacement energy depending on size of the unit and the source and location of the substitute unit.

²⁶ Vice-President and Chief Engineer, Southern Services, Inc., Birmingham, Ala. Mem. ASME.

The greatest savings from the construction of an outdoor or semioutdoor type of plant are effected when a "ranch-style" layout can be employed. This type of layout spreads the plant over a wider area and all major equipment, foundations, etc., are located at ground level. A majority of our plants are located on rivers which fluctuate 30 to 40 ft between extreme low flow and maximum flood-water elevations. In such locations, the condenser and other major equipment cannot be elevated sufficiently to be protected against flood damage without incurring prohibitive cooling-water pumping costs under low water and even under normal water-flow conditions. In a plant design of this type it will be generally found that approximately $\frac{1}{3}$ of the powerhouse building will be below ground level and $\frac{2}{3}$ above ground level. Since building volume below ground level costs approximately twice as much per cubic foot as it does above grade, it develops that the superstructure represents only 50 per cent of the total building cost. The potential savings resulting from the use of outdoor construction is therefore proportionately reduced.

In any plant, whether it be an indoor or outdoor type of design, consideration must be given not only to the initial cost of the plant but also to the maintenance and operating costs which will be incurred after it has been placed in operation. Because of the heavy rainfall (approximately 60 in. average per year) and also because of extreme and frequent changes in atmospheric conditions, including temperature, a judgment factor must be applied to cover the extra maintenance which undoubtedly will be incurred in adopting outdoor or semioutdoor designs. The cost of this added maintenance, after being capitalized, must be charged against the outdoor design and the amount of this penalty will vary according to judgment after making an unbiased evaluation of all of the factors which contribute to maintenance.

Despite the fact that there is only one plant constructed on this system which utilizes semioutdoor construction, the outdoor idea has not been completely overlooked. On the plant designs, which are currently being used, the induced-draft fans, dust collectors, stacks, recirculating fan, oil pumps, oil heaters, storage tanks, etc., are located outdoors. All of this equipment is located at ground level, and most of it had previously consumed building space. By locating these and other smaller items of equipment outdoors, it has been possible to effect a substantial reduction in building volume, structural steel, and other major components of building cost.

Since the basic problem is to reduce the cost of building structures, there can be only two avenues of approach, namely, either to reduce the cost to an acceptable minimum, or to disregard the value of a protective housing and completely eliminate the enclosure. Our studies have dictated that we should follow the first approach. Recent experience has demonstrated that building costs can be substantially reduced through the utilization of less expensive materials and the elimination of nonessential ornamental features. As an example, corrugated-asbestos siding has been found by experience to be an adequate substitute for brick walls. Its use effects a saving of approximately \$3 per sq ft and the resulting architectural appearance of the building is not at all displeasing.

Numerous studies have been made and many figures have been quoted covering the estimated amount of saving in construction costs which can be affected by utilizing outdoor or semioutdoor designs. There is a wide variation in the cost reductions which have been predicted and which have been reported. Perhaps the primary reason for the wide variation in the figures is that the actual saving which can be effected is a function of the base cost of the plant on which the savings are measured. Employing principles and methods of reasoning as generally outlined in the foregoing and without the use of outdoor or semioutdoor designs, the costs of new steam-generating units added to The Southern

Company system have been most encouraging and compare favorably with the very lowest costs reported by other companies without regard to the type of construction used.

E. J. GARBARINI.²⁷ An inherent advantage for the constructor in an outdoor power plant is the accessibility afforded for placing equipment and erecting component parts of the structure and apparatus. With the improved accessibility and with proper scheduling to have foundations and supports ready to receive apparatus upon its arrival at the job site, very often equipment and material can be unloaded from a railroad car by a truck crane and hauled directly to its permanent position, thus reducing cost by eliminating rehandling and also minimizing storage space requirements.

Better accessibility permits increased and more efficient use of mobile-power equipment to erect plant equipment and piping. Trucks and truck cranes can be utilized fully to place many items of apparatus in final position.

Scaffolding costs are reduced as a result of the omission of lighting and painting work in high places over operating levels.

Natural daylight affords better visibility than artificial lighting, and unless night shifts are used the cost of maintaining lights during construction is reduced.

Eliminating the building structure removes the need for some relatively high unit-cost operations, such as placing reinforced-concrete floors and roof decking at considerable heights above ground level.

Where the main crane does not have the capacity to lift the heaviest piece of the generator to be set during erection, the rigging and handling operations which are required are simplified by outdoor over indoor construction, especially as compared with indoor construction involving temporary omission of masonry building walls until getting heavy pieces moved inside.

The over-all field construction cost of an outdoor plant is normally less than for an enclosed plant of comparable design because of omitting certain elements of construction and thus reducing the number of units of work to be accomplished.

As the total number of work units is reduced, the total labor force can be smaller. This is of special importance in an area where manpower is in short supply.

However, the advantage of easy access is somewhat counterbalanced by the lack of protection for performing certain operations. As the severity of climatic conditions increases, this lack of protection can more than completely offset the gain from accessibility.

It is generally necessary to provide temporary shelters for a number of reasons, such as the following:

- (a) Protection of workmen from sun, wind, rain, and cold.
- (b) Protection of equipment from wind-borne dirt and rain.
- (c) Protection of equipment from temperature changes during alignment or setting to close tolerances. The main turbine-generator is the most critical piece of apparatus in this connection.
- (d) Protection of insulation from rain during application.

Some items of work are more expensive for outdoor construction, as for example, exposed conduit must be weatherproof, some slabs must have weatherproof membranes to act as roofs, and so on.

Inclement weather can be a problem if the schedule is tight, particularly if critical operations like turbine erection must be done in bad weather.

Although specific conditions will determine individual situations, in general, the over-all field construction costs are lower for outdoor plants than for indoor plants.

²⁷ Area Manager, Power Division, Bechtel Corporation, Los Angeles, Calif.

M. W. BURLESON²⁸ AND V. L. WHITACRE.²⁹ Since we are interested in this development only to the extent that it affects the life and performance of the thermal insulation, we are in no position to comment on the relative advantages and disadvantages except from the insulator's viewpoint. While we believe many people think of the insulation as a minor item in this era of high temperatures, it actually is no longer so minor, constituting about 5 per cent of the total cost of the plant. It, therefore, does deserve some close attention.

There is no question but that the insulation problem is vastly complicated when the protection of the building is removed. Unfortunately, insulation is not elastic and will not stretch. The inevitable result is that when equipment and piping expands the insulation must move and open up in places.

Where the plant is protected by a building, the problem is relatively simple. A poor job makes its own expansion joints in the insulation when the equipment expands and while the appearance may leave much to be desired the insulation will perform after a fashion. With a high-grade job, expansion joints are normally provided in the insulation so that the finish is not cracked by movement, the appearance is good and the insulation performs as it should. But even on a high-grade job there are, owing to interference and congestion, many places where the insulation cannot really be applied properly.

When the protection of the building is removed, all of this insulation must be weatherproofed. This is accomplished with asphalt-saturated felts, asphalts, sheet metal, asbestos-cement sheets, and other materials. It is relatively easy to apply many of the sheet or felt materials to straight piping effectively, but becomes extremely complicated over irregular surfaces, fittings, and similar equipment. The only practical means at present is to protect these areas with asphalt mastics.

The contact of mastics with hot-metal parts, the improper application of mastics, disregard of movement due to expansion (refer to Figs. 16, 17, 18), and other factors result in protection of the insulation which cannot be entirely weatherproofed.

²⁸ Johns-Manville Company, New York, N. Y.

²⁹ Insulation Manager, New York Power Products Department, Johns-Manville Sales Corporation, New York, N. Y. Mem. ASME.

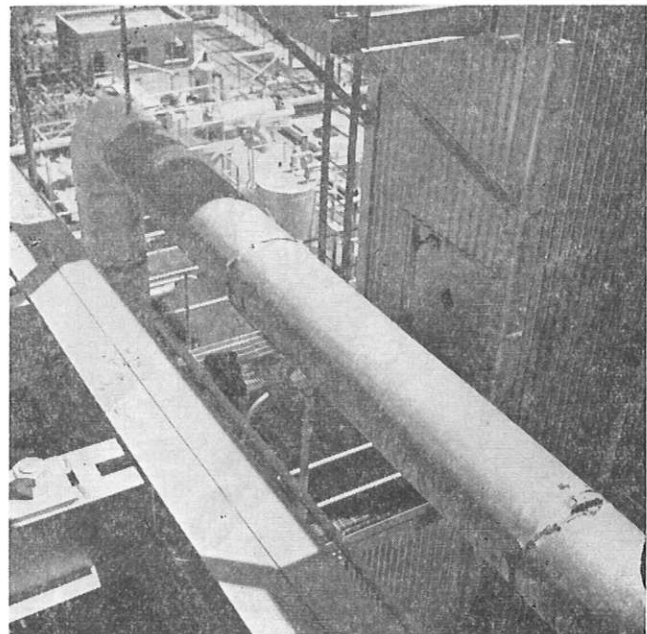

FIG. 16 VIEW SHOWING EFFECT OF EXPANSION AND SINGLE-LAYER CONSTRUCTION ON PIPE INSULATION WEATHERPROOFING

When the unit is in operation, the majority of the piping is sufficiently hot so that water which enters the insulation is quickly evaporated. In such cases, little harm apparently is done other than to increase the heat loss from the equipment. On the other hand, where the unit is shut down, water remains in the insulation and may result in serious corrosion of piping and equipment and increased insulation maintenance costs.

All of these factors add up the following:

- 1 Equipment and piping must be designed to be insulated (Figs. 19 and 20).
- 2 The specifications covering the application and weather-

proofing of insulation must be far more complete than previously. In present practice, the weatherproofing details are largely designed by the insulator who applies it.

3 The reliability of the insulation contractor becomes of greatest importance.

4 Some areas are so complicated that they should be housed anyway. Examples are feedwater heaters and the piping that surrounds them.

5 Frequent close inspection and maintenance of insulation.

There is another problem. Where outdoor power plants are built in climates that produce below-freezing temperatures at

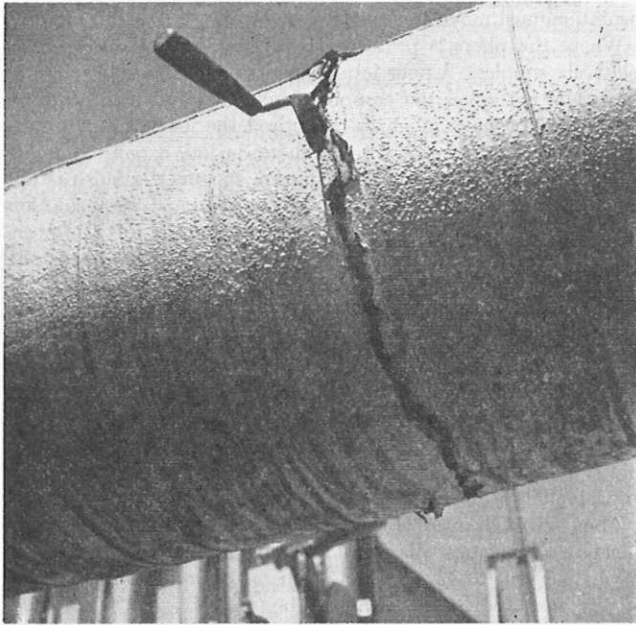

FIG. 17 CLOSE-UP OF INSULATION SHOWN IN FIG. 16

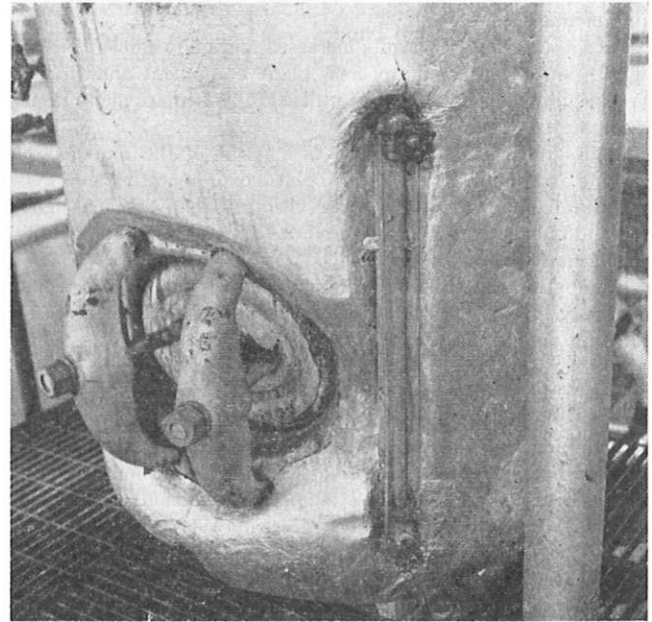

FIG. 19 INSULATION DESIGN INADEQUATE
(Glass should have been far enough from deaerating heater to permit proper insulation.)

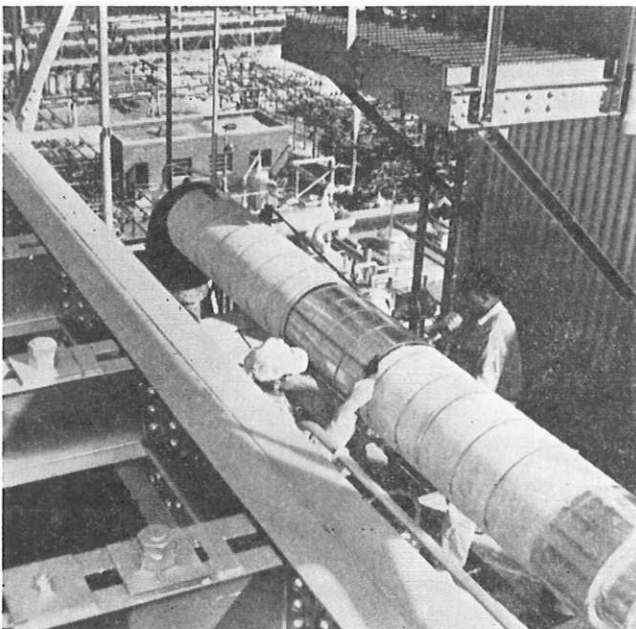

FIG. 18 REPAIR TO INSULATION SHOWN IN FIGS. 16 AND 17 BY CONSTRUCTION OF EXPANSION JOINTS AND APPLICATION OF NEW WEATHERPROOFING

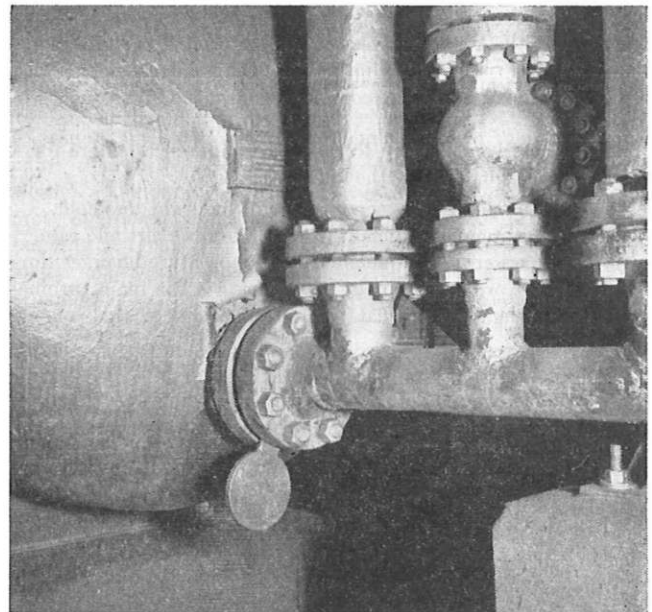

FIG. 20 BLOWDOWN TANK PIPING CONNECTION
(Original insulation failed and was not replaced. Congestion is too great to permit proper weatherproofing. This type equipment would be better under cover.)

times, all control lines and intermittent lines must be protected. This requires heaters of some sort on the piping and insulation to enable the heaters to be effective. Since these are not operating a large part of the time, there is no heat in the piping to dry out water that may leak into the insulation. Unless carefully weatherproofed, this condition can be a problem. Since the major problem is produced by shutdown periods on all heated piping and equipment, we have here a class of piping which is a major problem all of the time.

In conclusion, provisions for metal expansion and insulation protection for indoor installations cannot be translated directly into outdoor installations. Because of climatic conditions an outdoor insulation-protection specification acceptable in the southern climates would not be suitable for the northern climates.

The art of insulation protection has not progressed to the point where it is entirely acceptable to the exacting requirements of utilities, and it is only by close co-operation between the user and the manufacturer of insulation and insulation protections that a suitable specification can be developed.

H. C. DRAKE³⁰ AND W. E. MOORE.³¹ In selecting insulation for outdoor service, it is well to keep in mind three major points: (1) Will it stand up well under the more rigorous conditions of outdoor service? (2) Will its efficiency remain fairly constant during exposure over long periods—5 years, 10 years, or more? (3) What additional allowance should be made for labor costs and erection time, as compared with an indoor job?

A standard method of assuring durability and sustained efficiency is the application of a 22-gage metal jacket over conventional insulating material. Higher labor costs for this additional weather protection are to be anticipated as a result. Hunter

³⁰ President, Plant Economy, Inc., New York, N. Y.

³¹ Manufacturing Manager, Insulation Division, Hunter Manufacturing Corporation, Bristol, Pa.

aluminum insulation simplifies the problem of choosing outdoor protective insulating materials by meeting the heavier demands of outdoor service with one prefabricated covering, thereby reducing erection time and costs. This material is equally effective for indoor application, but for the purposes of this discussion its outdoor features will be stressed.

Product Description. (a) *Physical.* Unlike most conventional materials, this product is designed in individual units, completely shop-fabricated and easily handled. Each unit is composed of a series of aluminum-alloy sheets, separated by 1/2-in. dead air spaces, and held in place and supported by material of low heat conductivity.

The Hunter Aluminum Insulated Expansion Joint and/or Hanger Cover is engineered and fabricated to fit over existing hangers. The cutouts for the hanger support are incorporated in the insulation to receive the hanger support proper. The general design arrangement is similar to Hunter Aluminum Pipe Covering with the exception that it nests over adjoining pipe insulation.

One end of the expansion joint is mechanically secured to the adjoining pipe covering and is packed and sealed with calking compound. The opposite end of the expansion joint incorporates a self-sealing device that nests around the outer periphery of the adjoining pipe covering which extends partially into the expansion joint body. This arrangement permits expansion and contraction within the expansion joint itself, eliminating cracks and fractures as experienced in conventional block-type insulating material.

(b) *Technical.* An understanding of the heat-transfer principles used in the design of Hunter aluminum insulation is helpful, we think, in appreciating its value as an outdoor insulation. Fig. 26 illustrates the three principles used, namely, radiant, convection, and conduction heat transfer.

Heat emitted from the pipe heats up the adjacent confined air

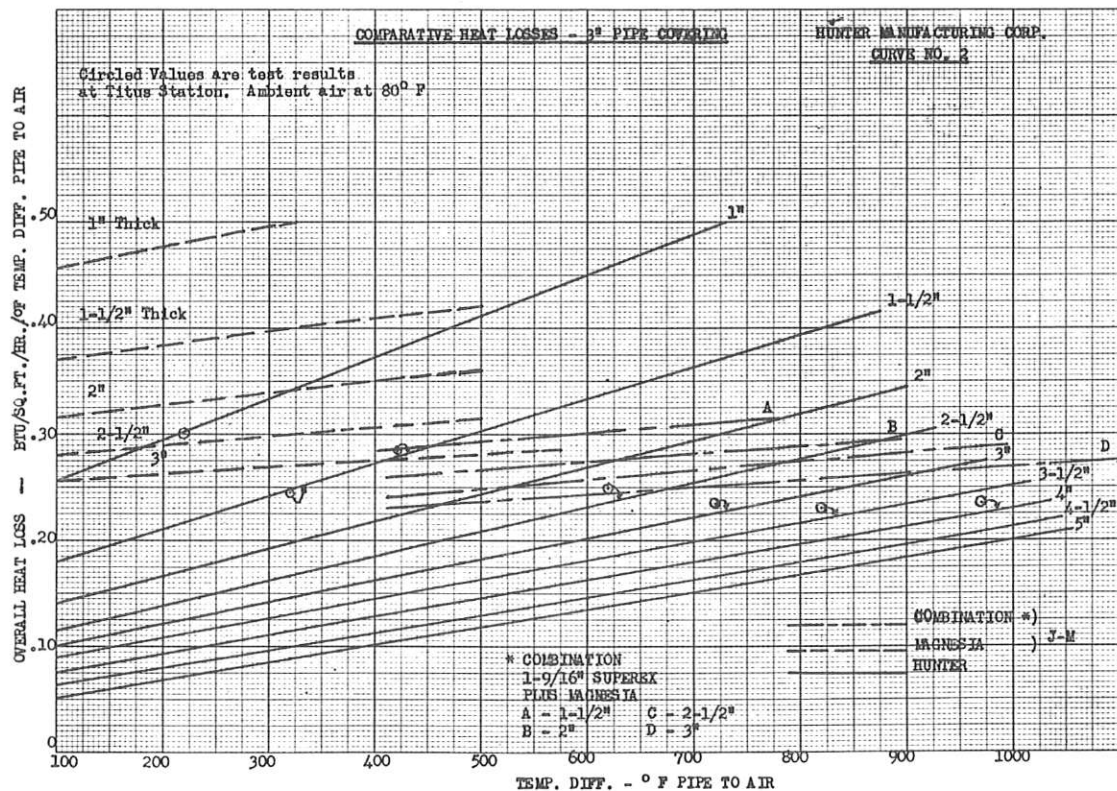

FIG. 21

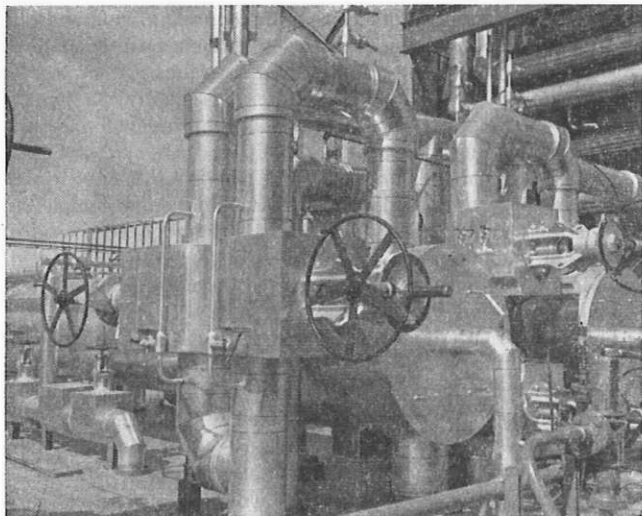

FIG. 22 FEEDWATER HEATERS AND PIPING OPERATING TEMPERATURE 800 F

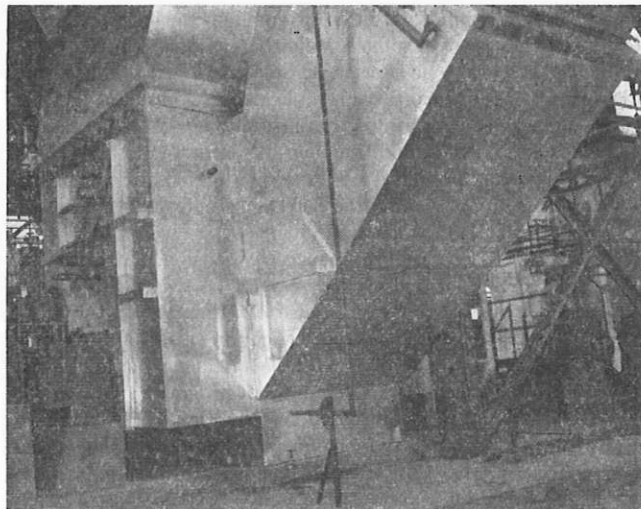

FIG. 24 INDUCED-DRAFT FAN OPERATING TEMPERATURE 360 F

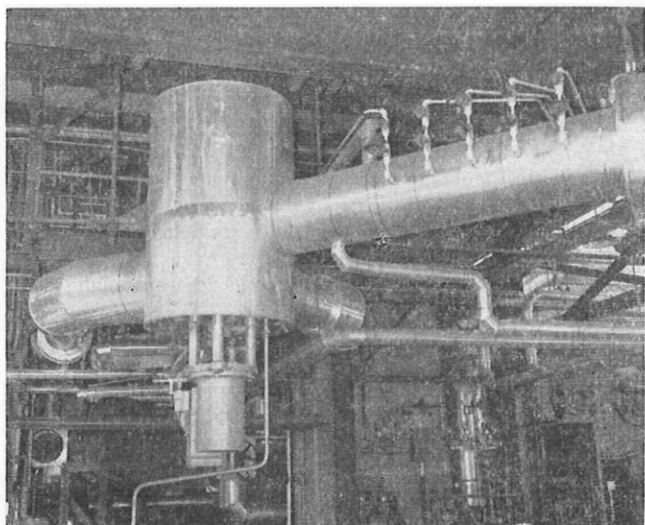

FIG. 23 MAIN STEAM THROTTLE VALVE OPERATING TEMPERATURE 1000 F

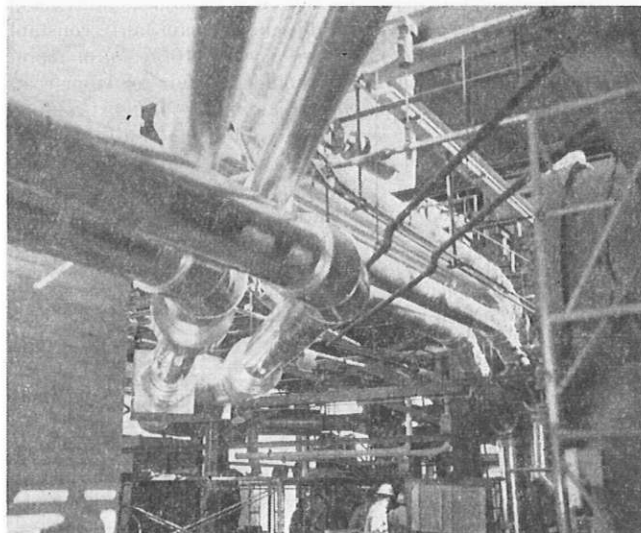

FIG. 25 MAIN STEAM AND BLEED PIPING OPERATING TEMPERATURE 1000 F

and radiates to the first aluminum-alloy sheet. Most of this radiated heat is reflected back to the source, but a small portion is transmitted to the first sheet, as a result of the convection currents set up through a temperature gradient across the first confined air space. This progressive heat-transfer process is repeated, layer by layer, and if carried far enough, would finally result in a reduction to practically zero heat loss. However, economy dictates confining the loss to a practical minimum by using the optimum number of aluminum layers.

The efficiency of an insulation of this sort depends on its reflective power. This "reflectivity" is inversely proportional to the metal's emissivity—or radiating power. To get the best performance and highest efficiency, a material of very low emissivity—hence very high reflective qualities—is used in Hunter insulation.

Since emissivity—or radiating power—is low, only a small portion of the total heat loss is the result of radiation; most is actually due to convection. On conventional block insulation the reverse is true, and because of this basic difference, Hunter aluminum insulation has a somewhat higher surface temperature

for comparable thicknesses. However, the over-all Btu heat losses for equal thicknesses are less, owing to the low emissivity of the aluminum alloy.

We are frequently asked if "hot spots" are created on the outer surfaces over the low heat conductivity spacers, since conductivity through these spacers is somewhat higher than through the spaced aluminum-alloy sheets. This is not the case, however, since the aluminum sheets serve as temperature equalizers, drawing off excess heat at each layer so that surface areas are uniform in temperature.

Durability. The question has been raised by some power-plant operators as to the ability of aluminum insulation to stand up under constant exposure to all kinds of weather. The basis for this is probably the fact that early experiments with aluminum as an insulation were mainly with the lighter-weight aluminum foils. The story is different with sheet aluminum. In Hunter insulation, the standard casing for indoor service runs from 0.040 to 0.051 in. thickness; and for outdoor service the equivalent of 22-gage steel can be used.

Because Hunter aluminum insulation is composed of a metal, primarily, it has certain features of durability not present in conventional insulating materials, which are of particular value in outdoor use:

1 It is resistant to thermal shock (or the sudden application of high-temperature gradients), either wet or dry. Damage in the form of stress-relieving cracks or disintegration, which sometimes occurs with bulk materials, is completely eliminated.

2 It will withstand physical vibration to a greater degree than other materials. There have been instances where conventional insulation has been fractured by vibration of ducts, from burner pulsation, by unbalanced fans or pulverizers, or by water hammer. With an aluminum alloy, this cannot happen.

3 It is dimensionally stable—wet or dry. Each individual insulating unit is designed to allow for expansion and contraction within the unit, with no stress or strain. Units are joined together so that expansion and contraction occur at predetermined locations, with expansion joints provided in the insulation at these points.

4 Because this material is a corrosion-resistant metal, it is naturally weatherproof and needs no additional protective paint or casing. Insulating units are fitted together to form mechanical seals which act as a protection from water penetration.

The retaining material of low conductivity is practically nonabsorbent. (On prolonged immersion, there is no more than 2 per cent surface wetting.) In addition, it is protected by the overlapped aluminum-alloy casings.

If an internal steam or water leak occurs—say, at a hanger, a joint, or at instrument connections—water from the inside should weep out without seriously affecting the insulating material. Location of the leak may be simplified, as well, since moisture from one leak should not travel beyond the section in which it occurs, causing further damage and lowering efficiency.

To prevent moisture penetration at joints, calking at cutouts for hanger supports and instrument connections, and special seals at expansion joints are provided, as required.

This greater weather resistance of Hunter aluminum insulation reduces the danger of corrosion of piping and equipment caused by retained moisture. With conventional bulk insulation—particularly on piping and equipment which is cold part, or all, of the time—corrosion may occur without a direct break in the basic insulation. When lines are cold, the empty air spaces in bulk

material will absorb whatever moisture exists in the ambient air through any joints that are not completely vapor sealed. These air cells are under a partial vacuum, developed when the moisture is initially driven out of the air cells on heating. With the lines cold, moisture is driven back into the air cells. In time, repetition of this process can cause loss of efficiency and progressive deterioration of the insulation, owing to the force of expanding steam in the cellular air spaces. In Hunter insulation, this phenomenon is negligible, since block-form insulation occupies only a small fraction of the total volume.

Efficiency. Fig. 21 compares heat losses from Hunter aluminum insulation with several standard materials. In all cases the Hunter product is more efficient for equivalent thicknesses, with efficiency increasing at higher temperatures. Actual operating results at the Titus Station of Metropolitan Edison Company, an indoor station where Hunter insulation is being used on all three units, have borne this out. After two years of operation, insulation efficiency was 98 to 100 per cent of the predicted and published values. (Actual heat losses on 3-in. pipe at this station are indicated by the circled values in Fig. 21.)

The ability of an insulating material to retain efficiency during prolonged operation without additional protective covering is of especial importance in outdoor service.

Bulk insulations, when used outdoors, are seldom 100 per cent dry, and the actual heat loss of such material in practice may be somewhat greater than the theoretical value. This is due to capillarity, which causes the retention of moisture in the material, even on hot surfaces. In contrast, Hunter insulation exhibits little or no dropoff in efficiency over long periods because of moisture or water accumulation.

Sustained higher insulation efficiency would reflect attractive savings in fuel costs over the life of the insulation that, though probably difficult to evaluate, have a tangible economic advantage.

Application. The third point to be considered in choosing an outdoor insulation is the comparative application time and total installed cost. Such a comparison should include not only initial cost but the expense of removing and replacing insulation during equipment maintenance. In this respect Hunter aluminum insulation offers several advantages readily reflected in dollar savings.

The need for protective painting or covering is entirely eliminated, since insulation surfaces are naturally durable and attractive. This is a direct saving in application time and material cost and in future maintenance costs.

Since this material will not absorb moisture and needs no drying out before application, it can be installed even under extreme weather conditions. One continuous erection period can be scheduled in advance, and no additional clean-up time is required, since there is no accumulation of dust or debris.

Labor and application costs are further reduced because only a single application is involved. Installation is also facilitated by the lighter weight of this insulation (about 1/2 the weight of standard materials) and by the ease with which insulating units can be snapped into place. This advantage is repeated each time equipment or piping is dismantled for maintenance; outage time is reduced, and replacement of insulation destroyed through removal is eliminated.

On projects that are a considerable distance from the Hunter Plant in Bristol, Pa., the manufacturer can arrange for job-site fabrication of all straight pipe covering and flat surface insulation. Special pieces—valve and fitting covers, etc.—are produced at the home plant.

Special Applications. The reflective qualities of Hunter aluminum insulation serve an additional purpose on steam and electric-traced lines for antifreeze protection. A resistance-heating

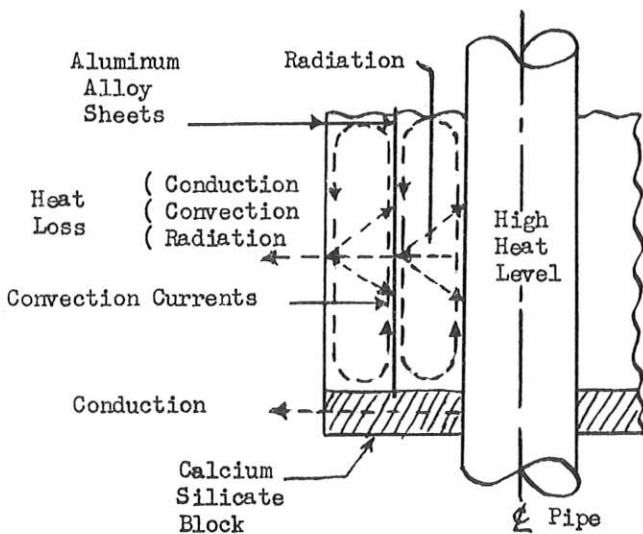

FIG. 26

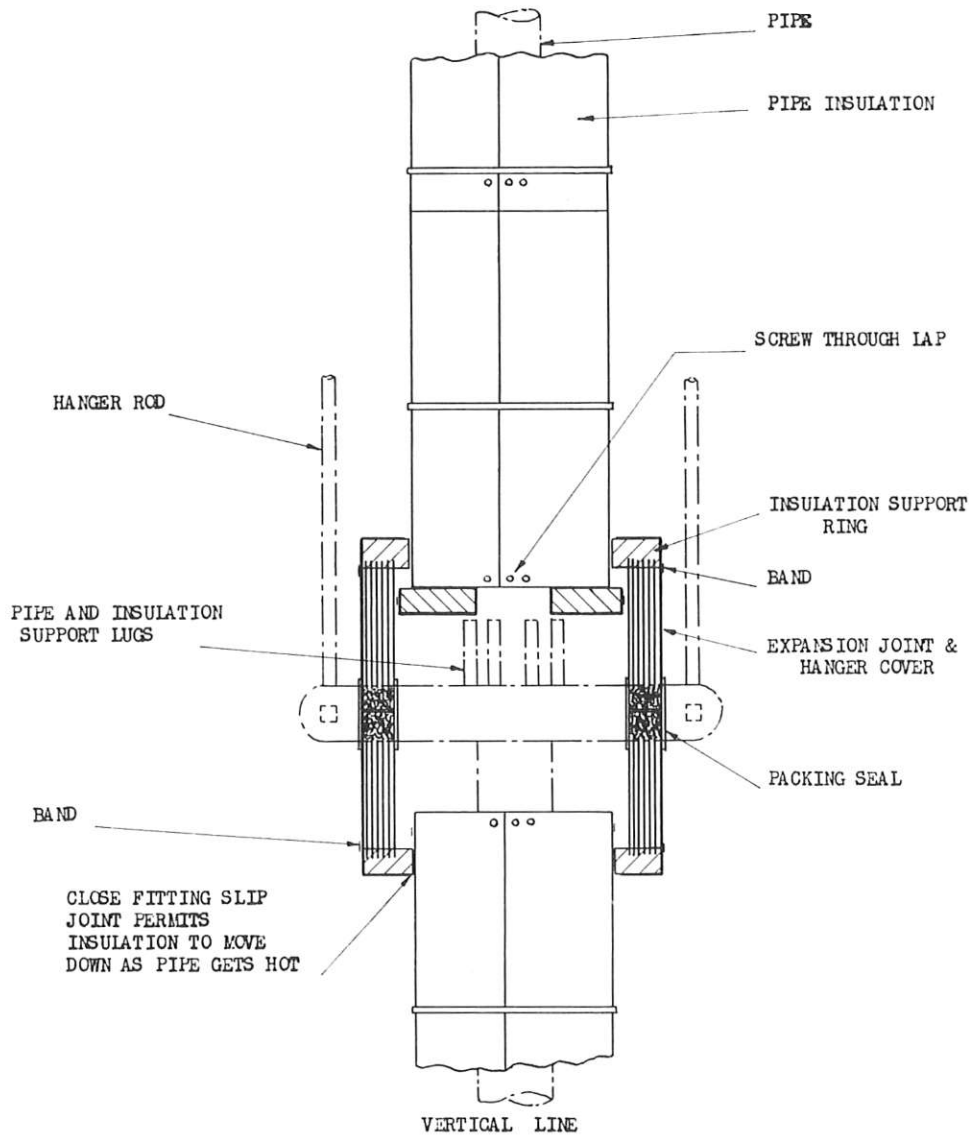

FIG. 27

cable may be run adjacent to the pipe or, if it is desired, to limit the maximum contact temperature of the tracer, in the $\frac{1}{2}$ -in. space between insulating layers. In either case, the heat from the tracer is well distributed around the pipe because of the reflectivity of the aluminum-alloy sheets, obviating the need for conventional contact heating. Notches are made during fabrication in the low conductivity material supporting spacers at the parting line to allow for passage of the heating cable and yet retain the removable features of the insulation.

On throttle valves, main steam leads, and bleed lines under turbines, that are situated close to lubricating-oil lines, this material is of considerable protective value. Being for all practical purposes nonabsorbent, the insulation cannot become

saturated with oil or inflammable fluids and act as a fire hazard for spontaneous combustion. If a fire does occur, it cannot become a long-burning wick to cause greater equipment damage.

For heater heads, flanges, valves, and other fittings, and for any equipment requiring periodic outages, maintenance is facilitated with Hunter latching-type removable insulation covers.

Conclusion. In conclusion, this insulation is a simplified competitive alternate to metal-lagged or mastic-coated insulations for outdoor use. It meets all the requirements of durability and offers, as well, greater flexibility and higher constant efficiency during prolonged service, expediting installation, and reducing maintenance costs.

Digests of Manufacturer Discussions

TURBINE MANUFACTURERS

The following constitutes a composite digest of written discussions submitted by the General Electric Company and Westinghouse Electric Corporation, in response to invitation:

Over the past 15 years approximately 50 turbine-generators have been put in operation with some degree of outdoor construction. Installations have been made in Florida on the sea coast where they are subject to ocean spray and hurricanes, in Texas where the climate is hot and dry with sandstorms, and in Montana where they have encountered winter snow and ice and temperatures as low as -40 F. These units are reliable and generally satisfactory with no significant difficulties.

Because of the lack of a building over the unit, both the initial installations and maintenance work have sometimes been delayed to some extent, but this has been accepted and generally the operators have liked the outdoor units.

The manufacturers believe that either of two arrangements will be most generally acceptable. The first is an arrangement with the turbine completely outdoors, the front standard weather-proofed with all control devices coming through packings so they are completely accessible. The space between the turbine and generator is covered with metal lagging, with the turning gear inside. The turbine metal lagging itself is made in as large pieces as can be handled with only a few bolts to be removed or clamping devices to be operated, so that access for maintenance is quick and easy. Weathertight doors with internal stairs and platforms are provided for access to the control valves and the turning gear. The generator itself is completely weatherproofed. The exciter has a walk-in-type housing so that brush inspection and minor maintenance work can be done regardless of the weather. While a few exciters have been furnished with weather-proofed enclosure and no walk-in housing, this has not generally been satisfactory and a walk-in-type housing is strongly recommended.

In regions where temperatures of zero or lower may be encountered for extended periods of time, it is considered necessary to provide heat insulation around the generator stator casing to be able to maintain a minimum temperature of 15 C inside. Heat is introduced by circulating hot water through the hydrogen coolers.

In extremely cold climates, the heating of the lubricating oil for cold starts is necessary. Also, provisions must be made to insure proper drainage if a unit has an extended shutdown period.

The hydrogen-treating system and control panel are all weatherproofed for outdoor installations with space heaters and thermostats provided where necessary to maintain the minimum temperatures.

The manufacturers have no hesitation in building turbine-generators for outdoor service.

BOILER MANUFACTURERS

Discussions were submitted by four boiler manufacturers: The Babcock & Wilcox Company, Combustion Engineering, Inc., Foster-Wheeler Corporation, and Riley Stoker Company. A composite of the discussions follows:

The four manufacturers number their outdoor boiler installations in the several hundreds. They include units of the following types: Reheat, nonreheat, natural circulation, controlled circulation, suction-fired, and pressure-fired, up to 2350

psi pressure and to 1,450,000 lb/hr. Practically every type of fuel firing is represented in the group. Neither the geographical location nor the elevation of plants now prohibits the use of entirely outdoor steam-generating equipment. Individual boiler units vary greatly as to the portions of the total equipment exposed to the weather, starting with units just having the air heaters, dust collectors, and fans outdoors, and extending through the complete range to those which have no part of the unit indoors or even supplementarily housed.

Weather protection for the operating and maintenance personnel varies from complete enclosures at the firing and drum levels to no special provision. The enclosures are usually constructed of transite and have provisions for both natural and artificial light, heat, and ventilation. The floors of these enclosures are concrete, arranged with proper pitch for drainage and to permit hosing down for good housekeeping. The roofs are either of transite construction, the extension of the boiler steel casing, or in the case of lower-most enclosures, concrete.

The development of automatic and remote manually operated controls for combustion, lighting off, soot blowers, and valves, together with television observation of furnace conditions and water level, is rapidly reducing the necessity for a large part of these enclosures as far as operating personnel is concerned.

Particular attention should be paid to the design of the weather-exposed structure so that all portions are self-draining and free from pockets in which water can accumulate.

Exposed horizontal steel preferably should be provided with sloping covers. Platforms and floors other than the main concrete floors are of the open galvanized grating type requiring little cleaning and no painting.

Experience has indicated that tarpaulins suspended from hooks connected to the supporting structure can provide satisfactory protection for maintenance crews if repairs must be made during inclement weather.

It is essential that all of the outside piping be completely drainable. As far as possible, it should be brought down at the side of the boiler to benefit from the radiated heat from the setting and be grouped so it can be easily and conveniently insulated and steel lagged. These enclosures are usually supplied with cord-type electric heaters or with steam tracing for use when the unit is out of service.

Except on outdoor boilers in mild-weather climates free from freezing, the recommendation is to house safety valves, water columns, and water-gage glasses.

Duct-work systems are arranged with their tops pitched for drainage and insulation may be applied either on the inside or the outside. If outside, the insulation is metal-sheathed or plastic-covered.

The forced-draft fans should be so located that the inlets will not pick up moisture and sand.

All bearings of all rotating equipment exposed to cold weather should be air-cooled if possible. In some cases where air cooling cannot be applied and subfreezing temperatures may be encountered, small thermostatically controlled electrical heaters are installed in the water-cooling system.

It is felt that the subject of boiler casings requires specific discussion, as sometimes the opinion is held that an indoor boiler can be insulated, then covered with a sealing coat of waterproof compound, but that an outdoor boiler requires a steel casing. The ready adaptation of boilers from indoor to outdoor use was possible from the very first because initially indoor boilers and their associated accessories were basically steel-encased equipment, which was reasonably pressure and watertight. Even up to very recently some manufacturers have been continuous exponents of a steel-cased design, first with bolted construction, then progressing to all-welded construction. How-

ever, steel shortages during the war years made it necessary to devise alternate weatherproofing material as a substitute for the steel casings which were being used. This led first to the use of transite casings, and then with the advancement of boiler and furnace design came walls which were insulated and covered with a coat of waterproof compound.

When properly designed the latter is economical and satisfactory for both indoor and outdoor types of installations. It inherently does not have the ruggedness of an outer steel casing, and as both designs are now available, decision as to the one to be used depends on the evaluation made by the client.

All the major builders have dropped exclusive advocacy of outside steel casings. Some manufacturers are currently marketing a design in which there is a pressure-type steel skin mounted directly on the boiler tubes, which is then backed with adequate insulating material, and then, in turn, covered with a waterproofing compound which is reinforced with glass-fiber material. Such a casing can be made positively tight, entirely weatherproof, and can be painted to be as attractive as a completely outside steel casing.

In summary, all builders take the stand that boiler units can be designed readily for complete or partial outdoor service at small additional cost over indoor installation. They report also that it is their opinion from discussions with operators who have outdoor boiler units properly designed for their specific climatic conditions that there are no serious operating or maintenance problems.

CENTRALIZED CONTROL MANUFACTURERS

Discussions were submitted by four manufacturers of control equipment: Bailey Meter Company, Hagan Corporation, Leeds & Northrup, and Republic. A composite of the discussions follows:

The control room is usually air conditioned just as with an indoor plant, with the result that instruments and control apparatus located therein operate under conditions which favor excellent performance and reduced maintenance. However, sensing and signaling devices for the various measurements of flow, level, pressure, and temperature are quite frequently located out of doors where they must combat a much wider temperature range, increased exposure to water and ice, sand and dirt, with strong winds increasing the adverse effects of these factors. In addition there may be the problem of increased distances between the central control room and the outlying controlled elements.

Manufacturers are paying more design attention to secure weathertight enclosure.

Exposed equipment will in general be less convenient for maintenance since the men involved will also be subjected to the prevailing weather conditions, and maintenance is made more difficult due to the necessity of opening weathertight enclosures not ordinarily required for indoor installations. There will naturally be a search for designs requiring even less maintenance than in the past, and increased use of corrosion-resistant materials to reduce maintenance on components located outdoors. One manufacturer states that because measuring and controlling units are generally small and can be taken to an indoor shop for

repair or overhaul the maintenance cost on these devices located outdoors is not likely to be appreciably higher than on similar units located indoors.

Hydraulic transmission of signals is giving way to pneumatic or electric transmission because long small high-pressure lines of hydraulic systems are difficult to protect against physical damage, freezing, and overheating when protected by heating.

Pneumatic systems in cold climates require driers to reduce the dew point of the compressed air below the minimum ambient temperature encountered. No special precaution is needed for the lines connecting to outdoor apparatus. With a suitable drier and a storage tank providing at least 15-min reserve, reliable power for signaling and control is assured for the outdoor plant.

Manufacturers with electrical transmission systems advocate their use. The requirement of weatherproof protection for conduits and connections to the outdoor apparatus to guard against insulation breakdown is pointed out. Outdoor motor operators require special attention to lubrication to insure reliable performance. Suitable outdoor electrical apparatus is available, although the cost of such equipment is somewhat higher than for indoor equipment.

Ice may form on forced-draft-fan vanes or dampers and on the connecting linkage between operators and dampers located out of doors. Power units for such devices should be made somewhat oversize to allow for ice-forming tendencies, and during icing conditions the power units should be operated periodically to break up any ice. Damper linkage should be protected against direct moisture impingement in icing areas.

It is always desirable where it can be done to install all measuring and control devices and panels within the building structure in enclosures provided for other operating reasons.

In many plants the outdoor mounted control equipment is limited to the forced and induced-draft fans, with a relatively trivial cost increase. If, however, the design is carried to the extent that measurement and control of water level, fuel, air flow, and furnace draft are all located outdoors, the installed cost will increase rather rapidly and maintenance cost also will be affected adversely.

The additional control cost for outdoor installations usually is not excessive, maintenance poses no severe problems, and the performance of a well-engineered outdoor job will equal the indoor plant installation.

PIPING FABRICATORS

The M. W. Kellogg Company comments that the only difference found on outdoor jobs as compared to indoor jobs is in the insulation requirements and the need for special housing of complicated hangers exposed to icing conditions. Midwest Piping Company notes the necessity of metal sheathing or bituminous coating on the insulation of outdoor piping to withstand the elements, coupled with provision of steam or electric tracers to prevent freezing; points out that on outdoor construction the absence of building steel may complicate the job of designing adequate hangers and supports, and states that erection experience to date has been fortunate, without sufficient bad weather to impede erection of the outdoor piping handled.

Summarization of Symposium Papers

BY V. F. ESTCOURT³² AND B. V. MARCELLUS,³³ SAN FRANCISCO, CALIF.

THE papers composing the symposium have been reviewed to collate the views of the several authors on points of similar nature.

INVESTMENT COSTS CHARGEABLE TO DESIGN

The two main reasons cited for adopting outdoor design are savings in first cost and reduction in construction time (Louis Elliott). In this section we will attempt to analyze the former. In the several papers there exists a wide variation in cost reductions reported for outdoor plants. E. C. Gaston rightly states that the actual saving is a function of the base cost on which the savings are measured. Two other yardstick bases for analysis have been suggested: Ebasco Services Incorporated use the full outdoor design, with penalties estimated for providing anything beyond the practical minimum of housing (W. F. Friend), while M. K. Drewry believes that outdoor design should be compared with minimum-cost practical enclosures.

F. W. Argue presents still another approach. In his paper, one comparison of savings is made by adjusting the costs of an existing conventional plant to that of the same plant in an outdoor arrangement and another, by adjusting the differences of cost in an existing outdoor plant versus the same plant in conventional design.

The different bases which the several authors have used in their cost analyses have resulted in a variety of predicted capital savings. It was noted that climatic conditions and the degree of outdoorness had a great bearing on the possible initial savings. The following is an attempt to correlate these data and explain the apparent discrepancies.

Over-All Cost Savings on Total Plant. The greatest savings of from \$6 to \$7 per kw of installed capacity can be made by adopting a fully outdoor design over a conventionally designed plant having brick or heavy masonry enclosures (T. M. Morong, G. A. Gaffert). A lesser saving of \$4 per kw is gained by installing only outdoor boilers and units with the remaining enclosure of brick or heavy masonry walls (E. C. Duffy) serving as protection for indoor-type auxiliary equipment.

A saving of \$1.66 to \$2.50 per kw was obtained in P.G.&E's Pittsburgh plant by adopting outdoor boilers and units with the remaining enclosure of heavy masonry as compared to a similar size plant with outdoor boilers and a heavy masonry enclosure for the turbine-generators. These savings include the gain reflected by optimum placement of the units (C. C. Wheelchel). The governor ends of the turbines project into the enclosed area thus eliminating walk-in enclosures and long runs of steam piping.

However, savings of only \$0.66 to \$2.85 per kw will be realized in adopting outdoor design if the enclosures to be eliminated are strictly functional, of inexpensive construction, and relying upon well-arranged masses for pleasing appearance (F. W. Argue). This variation in saving can be attributed to climatic conditions determining the type of enclosure being eliminated. In colder climates cost of enclosures will be increased by the required insulation.

Savings From Outdoor Boiler Installation. The outdoor boiler is firmly established (G. A. Gaffert) and materially reduces the first cost of a plant by eliminating a large section of building, together with accessories such as heating, ventilating, and

³² General Superintendent of Steam Generation, Pacific Gas & Electric Company. Fellow ASME.

³³ Technical Engineer, Pacific Gas & Electric Company. Mem. ASME.

cleaning equipment. Savings will exceed the additional cost for an outdoor boiler with the necessary weather protection, waterproofing, and steam tracing of lines (Paul Blanchard). Most of the over-all gain in savings comes from placing the boilers and heaters outdoors (John B. Saxe).

As noted before, the savings in placing any equipment outdoors is affected by the type of enclosure eliminated. If this is a functional enclosure, the savings with outdoor boilers will approximate only \$0.40 to \$2 per kw of installed capacity, depending upon whether the enclosure was designed for mild or cold-weather conditions (F. W. Argue). The size or capacity of the boiler also affects the savings. The savings decrease in inverse proportion to the size of the boiler. For example, E. C. Duffy's paper indicates the reduction in first cost by adopting semi-outdoor boiler design for single-boiler single-unit installations by the Long Island Lighting Company were \$4.47 for a 40,000-kw job, \$2.44 for a 90,000-kw unit, and \$1.96 for a 156,000-kw installation. In all cases the enclosures eliminated were of brick.

M. K. Drewry believes the saving in first cost by entirely omitting the boiler enclosure is not exactly justified for a steam plant located in a northern climate. The cost of an enclosure built from inexpensive materials such as corrugated transite will be recovered by reducing heat losses from the boiler. He estimates the cost of such an enclosure to be \$80,000 for a 120,000-kw installation (\$0.76 per kw) and the reduction in heat losses per year from such an enclosure to be \$75,000. Also, he estimates that a totally enclosed plant using transite-type walls and indoor equipment would approximate the cost of a fully outdoor plant of the same capacity.

Savings From Outdoor Turbine Installation. Placing the turbine-generator outdoors results in relatively small savings owing to the high cost of the gantry crane and walk-in housings (John B. Saxe). Also, there is very little difference between the cost of placing the turbine and switchgear indoors using conventional overhead crane and walls of corrugated transite and by adopting an outdoor unit and switchgear and using the more expensive gantry crane (G. A. Gaffert).

E. C. Duffy estimates the reduction of cost in an outdoor turbine installation including gantry crane, but exclusive of cost of unit, to be from \$1.64 to \$1.53 per kw of installed capacity for unit sizes from 90 mw to 156 mw, inclusive. In these cases, the eliminated enclosures were of brick construction.

W. D. Marsh and A. G. Mellor of the General Electric Company report that the additional cost of weatherproofing turbine-generators is between 2 and 4 per cent of the cost of the machine or \$0.50 to \$1.25 per kw.

F. W. Argue in his paper implies that the over-all saving in placing turbine-generator and related control room in an outdoor setting will vary between \$0.53 and \$0.72 per installed kw. These costs are based on the eliminated enclosure being of strictly functional design.

Savings Realized by Minimizing Enclosures. The elimination of usual boiler and turbine buildings will result in savings of from \$5 to \$8 per kw of capability depending upon whether the enclosure to be eliminated is of brick or of less expensive construction (John B. Saxe, W. L. Chadwick). Corrugated-asbestos siding is approximately \$3 per sq ft less than brick walls (E. C. Gaston).

Where the eliminated enclosure is of functional design, utilizing inexpensive materials, the initial savings will only be from

\$1.85 to \$2.35 per installed kw in an outdoor plant (F. W. Argue).

Miscellaneous Savings in Outdoor Design. The decrease in building services such as lighting, heating, and ventilation will amount to \$0.76 to \$1.35 per installed kw in an outdoor plant (F. W. Argue). The decrease will depend upon climatic conditions. At the Etiwanda Steam Station in Los Angeles, Calif., the reduction in the amount of necessary ventilating fans resulted in a savings of \$0.55 per installed kw (W. L. Chadwick). Mr. E. C. Duffy states that net savings for ventilation equipment in plants on Long Island, N. Y., were found to be approximately \$0.06 per kw of installed capacity.

Increased Cost of Mechanical and Electrical Equipment. Weatherproofing equipment for outdoor service increases its cost. F. W. Argue estimates the increase for electrical equipment to be from \$0.40 to \$0.50 per installed kw. W. D. Marsh and A. G. Mellor of the General Electric Company are in agreement with this as they say the total increase in cost of an outdoor turbine unit plus switchgear, exciters, motors, etc., will amount to \$1.65 per kw for a 100-mw installation while the increased cost of weatherproofing the unit alone is \$0.50 to \$1.25 per kw, depending upon the capacity. Thus \$1.65 minus \$1.25 would give \$0.40 per kw as the additional cost for electrical equipment for the larger unit.

The cost of mechanical equipment for outdoor service will average \$0.68 to \$1 per installed kw over that for indoor equipment (F. W. Argue).

Conclusion. The authors vary in the summation of all costs for conventional versus outdoor design plants. They show a variation of savings for outdoor designs amounting to anywhere from approximately zero (M. K. Drewry) to \$8 (W. L. Chadwick) per kw of installed capacity. This amount is dependent upon climatic conditions, installed capacity, and type of enclosure that has been eliminated. When all these are taken into consideration, there are no large discrepancies in the figures presented by the different authors. Perhaps the main difficulty is that insufficient emphasis has been made relative to the basis upon which the cost comparisons have been made.

CLIMATIC CONSIDERATIONS IN THE DESIGN, OPERATION, AND MAINTENANCE OF OUTDOOR STEAM PLANTS

Other than the savings in first cost, the most important factor influencing the design, operation, and maintenance of outdoor installations is climate. Sargent & Lundy, in its experience with the design and construction of some 25 units for outdoor service, believes that the outdoor plant has its place in the type of climate where it is not subjected to extremes of weather.

However, the acceptance of outdoor design is not universal. In the Southern Company system, it has been found that outdoor plants are not entirely feasible. The seasonal operational load variations are such that the minimum system demands coincide with the rainy and colder season of the year. Outages must be scheduled during this period and maintenance can be more efficiently and quickly completed where it can be performed within the protection of a building.

The question of indoor versus outdoor plants, so states M. K. Drewry, is a geographical and circumstantial one, that will never have a simple answer. For northern states, the Wisconsin Electric Power Company's experience suggests that inexpensive shelters are worth the investment. An interesting point offered by John B. Saxe is that in warm and arid areas the small saving from installing an outdoor turbine is amply warranted, particularly if the climate is being promoted and the utility is part of the act.

The effects of climatic considerations on the various phases of outdoor plants follow.

EFFECT OF CLIMATE ON DESIGN

Cold Weather. Outdoor boiler plants have been found practical in the severe cold of Montana and the freezing weather of Utah. Operational experience gained in these plants in subzero temperatures definitely shows that particular attention must be paid to the details of protecting all piping, valves, etc., carrying liquids or gases containing moisture. Safety valves, blowdown valves, water columns, air lines, control lines, and many drain lines have frozen in these plants even though every effort has been made to have these items insulated and traced (R. A. Reid, Paul Blanchard).

It is often possible to enclose the area beneath turbine pedestals at comparatively small cost in order to provide cold-weather protection for most of the auxiliary equipment. There appears little justification for enclosing dust collectors, induced-draft fans, and tanks. The problem of cold air entering the air preheaters appears to have been satisfactorily solved by the steam air preheater (W. L. Chadwick, T. M. Morong, John B. Saxe, E. C. Duffy).

Turbine-deck snow-melting systems have been proven by experience to be of limited usefulness (E. C. Duffy).

Temperature Extremes. The design of the Kyrene Steam Plant in Arizona was influenced by the climatic temperature range of 20 to 120 F. Periodic rains of torrential intensity and heavy dust storms also occur. As noted previously, the major auxiliaries are enclosed below the turbine deck by a lightweight concrete-block curtain wall. This arrangement provides protection from rain and dust and better maintenance conditions for the day-to-day work on the auxiliaries. The extreme temperature ranges can affect chlorinator operation if not adequately protected (T. M. Morong).

Mild Climates. The over-all design of P.G.&E.'s Pittsburgh full-outdoor plant has attained a considerable degree of enclosure for operators and certain equipment by taking full advantage of numerous structural situations where low-cost enclosure could be made at desirable points (C. C. Wheelchel). A porous gravel surface for the station yard is low in cost and rain water will seep into the ground without the need of a pipe drainage system (M. D. Engle).

Warm Climates. The boilers and heaters are the major dissipators of heat and it is practically impossible to provide satisfactory ventilation if they are enclosed (John B. Saxe, Louis Elliott). The enclosed area below turbine decks can be ventilated by hatches and/or by removable wall panels (E. C. Duffy).

Walk-In Enclosures. The consensus of opinion is that walk-in enclosures of some type are desirable for turbogenerators (H. G. Hiebeler, G. A. Gaffert, J. W. Keck). However, experience with an outdoor plant in Southern California has proven such enclosures are not necessary as they do not offer any more protection than can be obtained in a weatherproofed unit (W. L. Chadwick).

Manufacturers' Design. The major manufacturers of turbogenerators and boilers have no hesitation in building units to be reliable in operation and maintenance in the most adverse of weather conditions.

CLIMATIC CONSIDERATIONS IN CONSTRUCTION

There are no difficulties attendant to the erection of an outdoor plant during warm and mild weather. For this reason erection costs can be held to a minimum by scheduling major construction of boilers and turbines during periods of expected nice weather (E. C. Duffy). The lack of protection afforded by an outdoor plant retards construction as the severity of climatic conditions increases. Temporary and adequate protection of

turbine unit during erection is mandatory (E. J. Garbarini). The additional cost of the temporary shelter will be apparently less if the structure can be used year after year for turbine maintenance. Shelter costs of workmen and also for other equipment increase directly with the inclemency of the weather.

Inclement Weather. Construction lost time, according to E. C. Duffy, will probably not exceed 5 per cent in the case of boilers and 10 to 15 per cent for turbine-generators as a result of inclement weather. Turbine-erection costs normally have been estimated \$5000 to \$10,000 higher because of outdoor design. Experience has shown that the installation of a full boiler roof will save erection costs if construction has to be done during periods of inclement weather.

Winter Weather. Experience by the Wisconsin Electric Power Company has proven the need of sheltering workmen and equipment if erection is not to be delayed during the winter. M. K. Drewry notes that 50 per cent erection-labor efficiency results from men spending half their time warming themselves.

Rainy Weather. In locations with considerable precipitation, John B. Saxe and E. C. Duffy confirm that it is more logical to install a permanent roof over boilers as the cost of a temporary one during construction nearly approaches that of a permanent one.

CLIMATIC EFFECTS ON EMPLOYEE COMFORT

The improvement in employee comfort and contentment in outdoor plants, while intangible, is significant. Plants in areas of limited precipitation and high average temperatures offer definite advantages in personnel comfort, particularly in the more southern states. H. G. Hiebeler claims there is practically 100 per cent preference in all ranks for the outdoor arrangement of the Houston Lighting and Power Company plants.

It is to be expected that there are annoyances to operators where extremes of temperatures are involved. Operating soot blowers and other duties while facing a hot boiler casing with winter on the back is not conducive to good health of operators (G. A. Gaffert, John B. Saxe). In the Arizona Kyrene plant the operators have experienced discomfort in going from an air-conditioned control room at 70 F into a station ambient of 100 F. According to T. M. Morong the extreme temperature variations have resulted in more colds and an increase of time off.

OPERATION UNDER SEVERE WEATHER CONDITIONS

Dust Storms. Three to five years' experience in Texas with an outdoor plant has indicated no particular troubles arising from severe dust and sand storms that would not have occurred in a totally enclosed plant. In fact the nuisance would have been worse in a conventional plant since the dust and sand would have accumulated in the enclosed areas (C. W. Geue).

Hurricanes. Several outdoor plants in Florida and Texas have been exposed to winds approaching 125 mph, and it has been found by experience that outdoor plants, when properly designed, are as reliable as conventional plants under hurricane conditions. No plant shutdowns have occurred that could be attributed to the plants themselves. The vulnerable equipments are the outdoor switchyards and transmission lines. Indoor plants are not always dry during hurricanes (J. W. Keck, H. G. Hiebeler).

CLIMATIC EFFECTS ON MAINTENANCE

The weather has the greatest influence on the cost and duration of maintenance outages, and most, if not all, of the utilities schedule maintenance work in the milder seasons as far as system load patterns permit. G. A. Gaffert states the management of a steam plant in Louisiana consults with the weather bureau before an overhaul is planned.

Cold Weather. Maintenance, in general, during extremely cold weather will take longer and cost more than in a fully housed station (Louis Elliott). It has been found at Sewaren Generating Station that it takes two to three times as long to do close-tolerance work on lining-up rotary equipment (J. A. Inwright). However, even subfreezing temperatures and wet sleeting conditions are not a deterrent to any necessary maintenance. For example 18 coils were replaced in a 60,000-kw generator under these disadvantages in a Texas outdoor plant (H. G. Hiebeler). R. A. Reid doubts if cold weather is a handicap as men are more productive in cold as compared to hot conditions.

Paint Life. It is universally agreed that the problem of short paint life is common to all outdoor plants. At the present time, there has been no solution offered to combat the evil. It is apparent that it has to be tolerated. R. A. Reid suggests that outdoor painting costs are partially offset by not having extensive turbine and boiler structures to paint.

OPERATION AND MAINTENANCE COSTS

Operational costs, in general, as a result of outdoor design have decreased. This has been brought about by the compactness and optimum placement of equipment, improved instrumentation, and the very nature of the open arrangement tending toward the betterment of supervision and the observation of plant activities.

Maintenance costs are apparently increased, although diversity of opinion still exists on this score. The fact that the increased maintenance on equipment is somewhat counterbalanced by the reduction of maintenance on eliminated enclosures, plus the introduction of climatic effects, gives an explanation for this contradiction.

Operation. The cost of adequate centralized controls, so states T. M. Morong, has been well worth the investment in reduced personnel requirements.

No operational difficulties have appeared in the outdoor plants except that extreme temperature variations have resulted in more colds and time off for operating personnel (T. M. Morong). According to R. A. Reid, an outdoor plant subjected to the adverse weather conditions of Montana has not resulted in increased pay for the operators, and it is believed that less personnel are required.

Maintenance. In general, the consensus of opinion is that maintenance of outdoor equipment takes longer because it is necessary to spend additional time to protect and clean exposed parts, not normally required in a conventional plant.

It is universally accepted that cold or inclement weather has an adverse effect on outage time, particularly when close-tolerance work is attempted in extremely cold weather. J. A. Inwright notes that this latter will take two to three times as long.

The exposed breeching, ducts, and boiler casings need painting oftener than in conventional installations.

The disadvantages of outdoor maintenance are costly. However, there are a number of advantages which take away a great part of the sting. It is not unlikely that in some cases, due to climatic and other considerations, the maintenance costs will be less in an outdoor installation. Conversely, they could be appreciably greater.

The advantages of being out in the open, having natural light and sufficient space, has speeded up maintenance work. Another asset is the more pleasant working conditions. This is particularly true on outdoor boiler auxiliaries such as soot blowers, burners, fans, and so on.

Another advantage is the maintenance time saved in previous high-temperature areas. E. C. Duffy states that the saving

here outweighs lost time due to maintenance performed during low-temperature periods.

R. A. Reid doubts that cold weather is a handicap or that it increases maintenance costs.

The increased ease of routine cleaning in outdoor design by permitting the washing down of the open areas rather than sweeping or vacuum cleaning represents a saving (W. L. Chadwick).

MAINTENANCE OF INSULATION

The subject of additional maintenance cost on the outdoor pipe insulation has not been given the attention it warrants. Approximately 5 per cent of the capital investment in power plants is in pipe insulation, yet Johns-Manville Company states that the art of insulation has not progressed to the point where it is entirely acceptable to the exacting requirements of utilities. From cursory mention of the subject in the several papers on outdoor plants, the impression is given that the continual maintenance required is a necessary evil. There seems to be room for improvement. For instance, the Hunter Manufacturing Corporation states that the use of aluminum-alloy insulation in outdoor design will reduce maintenance costs and will impart sustained higher insulation efficiency.

CONSTRUCTION COSTS EXCLUSIVE OF CLIMATIC CONSIDERATIONS

There are two main reasons for adopting outdoor designs: The saving accomplished in first cost and the reduction in time and cost of the actual construction. This latter has been the subject of numerous studies and many figures have been quoted covering the estimated saving in construction costs effected by utilizing outdoor designs. The influence of the weather on construction costs is an adverse variable that, for the time being, will be left out of the picture (Louis Elliott, E. C. Gaston).

Possibly the greatest savings in construction costs are affected when a ranch-style layout can be employed. This type spreads the plant over a wider area and all major equipment, foundations, etc., are located at ground level (E. C. Gaston).

Outdoor plants tend toward simplification of design, thus automatically reducing construction costs. There remain many design features which may be changed to reduce these costs further (W. L. Chadwick, M. D. Engle).

The several basic advantages in outdoor design which contribute toward reducing the over-all construction costs are as follows:

Reduced Construction. Elements of construction, such as building structure, are omitted in the outdoor plant as compared to conventional plant of the same design (E. J. Garbarini).

Increased Accessibility. This inherent advantage in outdoor design aids the constructor in placing equipment and erecting component parts of the structure and apparatus. The improved accessibility makes it possible to use motorized moving and lifting equipment to better advantage. The elimination of structure walls extends the range of derricks and truck cranes. Trucks and truck cranes can be fully utilized to place many items of apparatus in final position. A large capacity caterpillar crane can be used during the initial plant erection, then later on in place of permanent steel structures and hoists (W. L. Chadwick, E. J. Garbarini, M. D. Engle).

Foundations. Since the foundation slab in outdoor design is often near ground level, the slab can be poured shortly after the construction force is organized, thus permitting the erection of boiler steel soon thereafter and the turbine-pedestal construction to follow shortly (Louis Elliott).

Concrete Work. The amount of reinforced-concrete floors and roof decking at considerable heights above ground level is reduced in outdoor plants (E. J. Garbarini).

Reduced Construction Personnel. The number of structural elements being less in outdoor design, a smaller labor crew is required. Construction supervision is noticeably more effective and there will be less interference between structural workers and equipment erectors (W. L. Chadwick, E. J. Garbarini).

Scaffolding Costs Reduced. The requirements for painting and electric-lighting fixtures in high places are reduced in outdoor design. This decreases scaffolding costs as well as electrical and painting costs (E. J. Garbarini).

Lighting Costs. The natural daylight affords better visibility and less artificial lighting is required during the construction of outdoor plants (E. J. Garbarini).

Some construction costs, will, of necessity, be more expensive in outdoor design plants than in conventional enclosed plants of the same capacity. The basic cause of this is the lack of protection resulting from eliminated enclosed structures. Some of the increased construction expenses are:

- 1 Providing temporary shelters for workmen, storing materials and equipment.

- 2 Protection of turbogenerator units during erection (E. J. Garbarini).

- 3 Weatherproofing of insulated steam, water, and oil lines requires additional labor and materials (Johns-Manville).

CONFLICT OF OPINION AND PREJUDICE PERTAINING TO OUTDOOR DESIGN

Outdoor design of steam plants has not found universal acceptance by the electric-power companies. There are, perhaps, many justifiable reasons to account for this. The question of indoor versus outdoor power plants, according to M. K. Drewry, is a geographical and circumstantial one that probably will never have a simple answer.

F. W. Argue believes it is unfortunate that controversy has developed regarding the feasibility of outdoor construction and that opinions have been formed without factual basis. At one extreme, there is doubt that outdoor stations are practical for other than the most favorable climate. This latter is more or less confirmed by G. A. Gaffert who notes that the outdoor plant has its place particularly in the type of climate where the plant is not subject to extremes of climate. Contrary to this, R. A. Reid has found from actual experience that outdoor plant operation is feasible for the severe climatic conditions of the Montana area. Also, E. C. Duffy intimates that outdoor plants are preferable particularly where there are long periods of hot weather as in New York.

Louis Elliott remembers in years past that in meetings of utility-industry committees, radical new ideas have more than once encountered tolerant pity from the conservatives. The installation outdoors of large boilers and turbines has run the gauntlet of ridicule, doubt, criticism, and gradual acceptance after the volume of successful installations commanded approval.

At the present there are no standards or definitions to indicate the degree of outdoorness of a steam plant. Mr. Elliott reminds us that outdoor is a convenient, and nowadays a conventional term for denoting plants in which one or more important units of equipment are installed without protection from the weather.

REASONS HINDERING UTILIZATION OF OUTDOOR DESIGN

Two very different versions are offered for the delay in applying the outdoor design to power plants. J. W. Keck indicates one reason being that it was necessary to adapt much equipment for outdoor use, such as turbines, exciters, motors, instrument panels, etc. F. W. Argue believes that outdoor construction did not receive widespread acceptance until instrumentation and

automatic control had reached the stage where routine operations could be remotely controlled.

ARGUMENTS AGAINST OUTDOOR DESIGN

E. C. Gaston explains that outdoor design has not been employed more frequently in the Southern Services, Inc. as the distribution of hydro and steam capacities and system load is such that maintenance outages on steam-electric plants have to be scheduled during the season of heavy rainfall and inclement weather. These adverse climatic conditions may so increase maintenance costs that the increase, when capitalized, would offset any saving in eliminating enclosures.

NOISE PROBLEM

Another debatable issue is noise control. It is W. L. Chadwick's contention that this may be serious enough at some station sites practically to eliminate the possibility of outdoor design. Contrarywise, E. C. Duffy has established through the actual operation of outdoor boilers and turbines of the Long Island Lighting Company that sound emanating from such equipment is rapidly attenuated, and the noise level at various distances has created no noise problem. As a matter

of fact, experiences with brick enclosures indicated that the effect was similar to a piano sounding board, resulting in amplification of the power-plant noise to surrounding areas.

CONCLUDING OBSERVATIONS

Extremely important data on the advantages and disadvantages of outdoor construction have been presented by the various authors. It is believed that many of the apparently divergent views could be reconciled in greater degree if a more careful study were made of the premises upon which each statement is based. The basic problem appears to center around the degree and type of outdoorness which will yield the minimum overall cost of production, including fixed charges, for various types of climate and system operating requirements. It would be an oversimplification of the problem to decide the case merely "for" or "against" the outdoor plant.

If a future symposium is held on this subject, it should include a very careful appraisal of the data presented by the present authors in terms of the four factors mentioned in the foregoing.

Very definite appreciation is due the many authors for their valuable contributions in this Symposium.